

Technical parameters for heat pump space heaters and heat pump combination heaters

Model(s):	HU163 U33 / HN1616T NB0	
Air-to-water heat pump:	YES	NO
Water-to-water heat pump:	YES	NO
Brine-to-water heat pump:	YES	NO
Low-temperature heat pump:	YES	NO
Equipped with a supplementary heater:	YES	NO
Heat pump combination heater:	YES	NO
Parameters shall be declared for medium-temperature application, except for low-temperature heat pumps.		
For low-temperature heat pumps, parameters shall be declared for low-temperature application.		
Parameters shall be declared for average climate conditions.		

Low temperature application

Item	Symbol	Value	Unit
Rated heat output (*)	P_{rated}	11	kW
Declared capacity for heating for part load at indoor temperature 20 °C and outdoor temperature T_j			
$T_j = -7\text{ °C}$	P_{dh}	9.6	kW
$T_j = +2\text{ °C}$	P_{dh}	5.8	kW
$T_j = +7\text{ °C}$	P_{dh}	3.7	kW
$T_j = +12\text{ °C}$	P_{dh}	3.9	kW
$T_j = \text{bivalent temperature}$	P_{dh}	10.8	kW
$T_j = \text{operation limit temperature}$	P_{dh}	10.8	kW
For air-to-water heat pumps: $T_j = -15\text{ °C}$ (if TOL < -20°C)	P_{dh}	x,x	kW
Bivalent temperature	T_{biv}	-10	°C
Cycling interval capacity for heating	P_{cyc}	x,x	kW
Degradation co-efficient(**)	C_{dh}	0.9	

Item	Symbol	Value	Unit
Seasonal space heating energy efficiency	η_s	163%	
Declared coefficient of performance or primary energy ratio for part load at indoor temperature 20 °C and outdoor temperature T_j			
$T_j = -7\text{ °C}$	COPd or PERd	2.63	– or %
$T_j = +2\text{ °C}$	COPd or PERd	3.83	– or %
$T_j = +7\text{ °C}$	COPd or PERd	5.93	– or %
$T_j = +12\text{ °C}$	COPd or PERd	8.14	– or %
$T_j = \text{bivalent temperature}$	COPd or PERd	2.23	– or %
$T_j = \text{operation limit temperature}$	COPd or PERd	2.23	– or %
For air-to-water heat pumps: $T_j = -15\text{ °C}$ (if TOL < -20°C)	COPd or PERd	x,xx	– or %
Cycling interval efficiency	COPcyc or PERcyc	x,xx	– or %
Heating water operating limit temperature	WTOL	57	°C

Medium temperature application

Item	Symbol	Value	Unit
Rated heat output (*)	P_{rated}	10	kW
Declared capacity for heating for part load at indoor temperature 20 °C and outdoor temperature T_j			
$T_j = -7\text{ °C}$	P_{dh}	8.7	kW
$T_j = +2\text{ °C}$	P_{dh}	5.3	kW
$T_j = +7\text{ °C}$	P_{dh}	3.4	kW
$T_j = +12\text{ °C}$	P_{dh}	3.9	kW
$T_j = \text{bivalent temperature}$	P_{dh}	9.8	kW
$T_j = \text{operation limit temperature}$	P_{dh}	9.8	kW
For air-to-water heat pumps: $T_j = -15\text{ °C}$ (if TOL < -20°C)	P_{dh}	x,x	kW
Bivalent temperature	T_{biv}	-10	°C
Cycling interval capacity for heating	P_{cyc}	x,x	kW
Degradation co-efficient(**)	C_{dh}	0.9	

Item	Symbol	Value	Unit
Seasonal space heating energy efficiency	η_s	117%	
Declared coefficient of performance or primary energy ratio for part load at indoor temperature 20 °C and outdoor temperature T_j			
$T_j = -7\text{ °C}$	COPd or PERd	1.93	– or %
$T_j = +2\text{ °C}$	COPd or PERd	2.82	– or %
$T_j = +7\text{ °C}$	COPd or PERd	4.05	– or %
$T_j = +12\text{ °C}$	COPd or PERd	5.86	– or %
$T_j = \text{bivalent temperature}$	COPd or PERd	1.62	– or %
$T_j = \text{operation limit temperature}$	COPd or PERd	1.62	– or %
For air-to-water heat pumps: $T_j = -15\text{ °C}$ (if TOL < -20°C)	COPd or PERd	x,xx	– or %
For air-to-water heat pumps: Operation limit temperature	TOL	-15	°C
Cycling interval efficiency	COPcyc or PERcyc	x,xx	– or %
Heating water operating limit temperature	WTOL	57	°C

Power consumption in modes other than active mode			
Off mode	P_{OFF}	0.005	kW
Thermostat-off mode	P_{TO}	0.060	kW
Standby mode	P_{SB}	0.005	kW
Crankcase heater mode	P_{CK}	0.039	kW

Supplementary heater			
Rated heat output (*)	P_{sup}	3.8	kW
Type of energy input	Electric		

Other items			
Capacity control	Variable		
Sound power level, indoors/outdoors	$L_{WA,indoor}$	36	dB
	$L_{WA,outdoor}$	66	dB
Annual electricity consumption (Low Temp)	Q HE, (Low Temp)	5376	kWh
Annual electricity consumption (Mid Temp)	Q HE, (Mid Temp)	6755	kWh

For air-to-water heat pumps: Rated air flow rate, outdoors (Low Temp)	6762	m ³ /h
For air-to-water heat pumps: Rated air flow rate, outdoors (Mid. Temp)	7512	m ³ /h
For water-/brine-to-water heat pumps: Rated brine or water flow rate, outdoor heat exchanger	x	
Water Pump EEI	≤	0.20
*The benchmark for the most efficient circulators is EEI ≤ 0,20.;		

For heat pump combination heater			
Declared load profile	XL		
Daily electricity consumption	Qelec	9.0	kWh
Annual electricity consumption	AEC	1,881	kWh

Water heating energy efficiency	η_{wh}	89%	%
Daily fuel consumption	Qfuel	0	kWh
Annual fuel consumption	AFC	0	GJ

Contact details
 Name : Christianna Papazahariou
 Position : European Regulatory Manager
 E-mail address : chris.papazahariou@lge.com Tel. 01 49 89 57 41 – 06 83 077 455
 Postal address : Paris Nord II – 117 avenue des Nations BP 59372
 Villepinte – 95942 Roissy CDG Cedex
 www.lg.com

(*) For heat pump space heaters and heat pump combination heaters, the rated heat output P_{rated} is equal to the design load for heating $P_{design,h}$, and the rated heat output of a supplementary heater P_{sup} is equal to the supplementary capacity for heating $sup(T_j)$.

(**) If C_{dh} is not determined by measurement then the default degradation coefficient is $C_{dh} = 0,9$.

Warmer climate

Low temperature application

Item	Symbol	Value	Unit
Rated heat output (*)	P_{rated}	11	kW
Declared capacity for heating for part load at indoor temperature 20 °C and outdoor temperature T_j			
$T_j = + 2\text{ °C}$	P_{dh}	10.8	kW
$T_j = + 7\text{ °C}$	P_{dh}	6.9	kW
$T_j = + 12\text{ °C}$	P_{dh}	3.5	kW
$T_j =$ bivalent temperature	P_{dh}	10.8	kW
$T_j =$ operation limit temperature	P_{dh}	10.8	kW
For air-to-water heat pumps: $T_j = -15\text{ °C}$ (if TOL < -20°C)	P_{dh}	x,x	kW
Bivalent temperature	T_{biv}	2	°C
Cycling interval capacity for heating	P_{cych}	x,x	kW
Degradation co-efficient(**)	C_{dh}	0.9	

Item	Symbol	Value	Unit
Seasonal space heating energy efficiency	η_s	214%	
Declared coefficient of performance or primary energy ratio for part load at indoor temperature 20 °C and outdoor temperature T_j			
$T_j = + 2\text{ °C}$	COPd or PERd	2.80	– or %
$T_j = + 7\text{ °C}$	COPd or PERd	4.85	– or %
$T_j = + 12\text{ °C}$	COPd or PERd	7.10	– or %
$T_j =$ bivalent temperature	COPd or PERd	2.80	– or %
$T_j =$ operation limit temperature	COPd or PERd	2.80	– or %
For air-to-water heat pumps: $T_j = -15\text{ °C}$ (if TOL < -20°C)	COPd or PERd	x,xx	– or %
Cycling interval efficiency	COPcyc or PERcyc	x,xx	– or %

Medium temperature application

Item	Symbol	Value	Unit
Rated heat output (*)	P_{rated}	10	kW
Declared capacity for heating for part load at indoor temperature 20 °C and outdoor temperature T_j			
$T_j = + 2\text{ °C}$	P_{dh}	9.8	kW
$T_j = + 7\text{ °C}$	P_{dh}	6.3	kW
$T_j = + 12\text{ °C}$	P_{dh}	3.5	kW
$T_j =$ bivalent temperature	P_{dh}	9.8	kW
$T_j =$ operation limit temperature	P_{dh}	9.8	kW
For air-to-water heat pumps: $T_j = -15\text{ °C}$ (if TOL < -20°C)	P_{dh}	x,x	kW
Bivalent temperature	T_{biv}	2	°C
Cycling interval capacity for heating	P_{cych}	x,x	kW
Degradation co-efficient(**)	C_{dh}	0.9	

Item	Symbol	Value	Unit
Seasonal space heating energy efficiency	η_s	144%	
Declared coefficient of performance or primary energy ratio for part load at indoor temperature 20 °C and outdoor temperature T_j			
$T_j = + 2\text{ °C}$	COPd or PERd	2.00	– or %
$T_j = + 7\text{ °C}$	COPd or PERd	3.20	– or %
$T_j = + 12\text{ °C}$	COPd or PERd	4.90	– or %
$T_j =$ bivalent temperature	COPd or PERd	2.00	– or %
$T_j =$ operation limit temperature	COPd or PERd	2.00	– or %
For air-to-water heat pumps: $T_j = -15\text{ °C}$ (if TOL < -20°C)	COPd or PERd	x,xx	– or %
Cycling interval efficiency	COPcyc or PERcyc	x,xx	– or %

Annual electricity consumption (Low Temp)	$Q_{HE, (Low Temp)}$	2665	kWh
Annual electricity consumption (Mid Temp)	$Q_{HE (Mid Temp)}$	3559	kWh

Colder climate

Low temperature application

Item	Symbol	Value	Unit
Rated heat output (*)	P_{rated}	13	kW
Declared capacity for heating for part load at indoor temperature 20 °C and outdoor temperature T_j			
$T_j = -7\text{ °C}$	P_{dh}	7.8	kW
$T_j = +2\text{ °C}$	P_{dh}	4.8	kW
$T_j = +7\text{ °C}$	P_{dh}	3.8	kW
$T_j = +12\text{ °C}$	P_{dh}	3.9	kW
$T_j =$ bivalent temperature	P_{dh}	9.2	kW
$T_j =$ operation limit temperature	P_{dh}	9.2	kW
For air-to-water heat pumps:			
$T_j = -15\text{ °C}$ (if TOL < -20°C)	P_{dh}	x,x	kW
Bivalent temperature	T_{biv}	-15	°C
Cycling interval capacity for heating	P_{cyc}	x,x	kW
Degradation co-efficient(**)	C_{dh}	0.9	

Item	Symbol	Value	Unit
Seasonal space heating energy efficiency	η_s	118%	
Declared coefficient of performance or primary energy ratio for part load at indoor temperature 20 °C and outdoor temperature T_j			
$T_j = -7\text{ °C}$	COPd or PERd	2.70	or %
$T_j = +2\text{ °C}$	COPd or PERd	3.72	or %
$T_j = +7\text{ °C}$	COPd or PERd	5.70	or %
$T_j = +12\text{ °C}$	COPd or PERd	7.90	or %
$T_j =$ bivalent temperature	COPd or PERd	2.05	or %
$T_j =$ operation limit temperature	COPd or PERd	2.05	or %
For air-to-water heat pumps:			
$T_j = -15\text{ °C}$ (if TOL < -20°C)	COPd or PERd	x,xx	or %
Cycling interval efficiency	COPcyc or PERcyc	x,xx	or %

Medium temperature application

Item	Symbol	Value	Unit
Rated heat output (*)	P_{rated}	12	kW
Declared capacity for heating for part load at indoor temperature 20 °C and outdoor temperature T_j			
$T_j = -7\text{ °C}$	P_{dh}	7.1	kW
$T_j = +2\text{ °C}$	P_{dh}	4.3	kW
$T_j = +7\text{ °C}$	P_{dh}	3.3	kW
$T_j = +12\text{ °C}$	P_{dh}	3.9	kW
$T_j =$ bivalent temperature	P_{dh}	8.6	kW
$T_j =$ operation limit temperature	P_{dh}	8.6	kW
For air-to-water heat pumps:			
$T_j = -15\text{ °C}$ (if TOL < -20°C)	P_{dh}	x,x	kW
Bivalent temperature	T_{biv}	-15	°C
Cycling interval capacity for heating	P_{cyc}	x,x	kW
Degradation co-efficient(**)	C_{dh}	0.9	

Item	Symbol	Value	Unit
Seasonal space heating energy efficiency	η_s	87%	
Declared coefficient of performance or primary energy ratio for part load at indoor temperature 20 °C and outdoor temperature T_j			
$T_j = -7\text{ °C}$	COPd or PERd	1.90	or %
$T_j = +2\text{ °C}$	COPd or PERd	2.70	or %
$T_j = +7\text{ °C}$	COPd or PERd	3.80	or %
$T_j = +12\text{ °C}$	COPd or PERd	5.45	or %
$T_j =$ bivalent temperature	COPd or PERd	1.48	or %
$T_j =$ operation limit temperature	COPd or PERd	1.48	or %
For air-to-water heat pumps:			
$T_j = -15\text{ °C}$ (if TOL < -20°C)	COPd or PERd	x,xx	or %
Cycling interval efficiency	COPcyc or PERcyc	x,xx	or %

Annual electricity consumption (Low Temp)	Q HE, (Low Temp)	10562	kWh
Annual electricity consumption (Mid Temp)	Q HE (Mid Temp)	12836	kWh

Technical parameters for heat pump space heaters and heat pump combination heaters

Model(s):	HU163 U33 / HN1639 NK3, HU163 U33 / HN1636M NK5	
Air-to-water heat pump:	YES	NO
Water-to-water heat pump:	YES	NO
Brine-to-water heat pump:	YES	NO
Low-temperature heat pump:	YES	NO
Equipped with a supplementary heater:	YES	NO
Heat pump combination heater:	YES	NO
Parameters shall be declared for medium-temperature application, except for low-temperature heat pumps.		
For low-temperature heat pumps, parameters shall be declared for low-temperature application.		
Parameters shall be declared for average climate conditions.		

Low temperature application

Item	Symbol	Value	Unit
Rated heat output (*)	P_{rated}	10	kW
Declared capacity for heating for part load at indoor temperature 20 °C and outdoor temperature T_j			
$T_j = -7\text{ °C}$	P_{dh}	8.8	kW
$T_j = +2\text{ °C}$	P_{dh}	5.4	kW
$T_j = +7\text{ °C}$	P_{dh}	4.1	kW
$T_j = +12\text{ °C}$	P_{dh}	4.6	kW
$T_j =$ bivalent temperature	P_{dh}	10.0	kW
$T_j =$ operation limit temperature	P_{dh}	10.0	kW
For air-to-water heat pumps: $T_j = -15\text{ °C}$ (if TOL < -20°C)	P_{dh}	x,x	kW
Bivalent temperature	T_{biv}	-10	°C
Cycling interval capacity for heating	P_{cyc}	x,x	kW
Degradation co-efficient(**)	C_{dh}	0.9	

Item	Symbol	Value	Unit
Seasonal space heating energy efficiency	η_s	169%	
Declared coefficient of performance or primary energy ratio for part load at indoor temperature 20 °C and outdoor temperature T_j			
$T_j = -7\text{ °C}$	COPd or PERd	2.55	– or %
$T_j = +2\text{ °C}$	COPd or PERd	4.15	– or %
$T_j = +7\text{ °C}$	COPd or PERd	6.10	– or %
$T_j = +12\text{ °C}$	COPd or PERd	8.30	– or %
$T_j =$ bivalent temperature	COPd or PERd	2.30	– or %
$T_j =$ operation limit temperature	COPd or PERd	2.30	– or %
For air-to-water heat pumps: $T_j = -15\text{ °C}$ (if TOL < -20°C)	COPd or PERd	x,xx	– or %
Cycling interval efficiency	COPcyc or PERcyc	x,xx	– or %
Heating water operating limit temperature	WTOL	57	°C

Medium temperature application

Item	Symbol	Value	Unit
Rated heat output (*)	P_{rated}	10	kW
Declared capacity for heating for part load at indoor temperature 20 °C and outdoor temperature T_j			
$T_j = -7\text{ °C}$	P_{dh}	8.8	kW
$T_j = +2\text{ °C}$	P_{dh}	5.3	kW
$T_j = +7\text{ °C}$	P_{dh}	3.6	kW
$T_j = +12\text{ °C}$	P_{dh}	4.1	kW
$T_j =$ bivalent temperature	P_{dh}	9.9	kW
$T_j =$ operation limit temperature	P_{dh}	9.9	kW
For air-to-water heat pumps: $T_j = -15\text{ °C}$ (if TOL < -20°C)	P_{dh}	x,x	kW
Bivalent temperature	T_{biv}	-10	°C
Cycling interval capacity for heating	P_{cyc}	x,x	kW
Degradation co-efficient(**)	C_{dh}	0.9	

Item	Symbol	Value	Unit
Seasonal space heating energy efficiency	η_s	130%	
Declared coefficient of performance or primary energy ratio for part load at indoor temperature 20 °C and outdoor temperature T_j			
$T_j = -7\text{ °C}$	COPd or PERd	1.93	– or %
$T_j = +2\text{ °C}$	COPd or PERd	3.15	– or %
$T_j = +7\text{ °C}$	COPd or PERd	4.79	– or %
$T_j = +12\text{ °C}$	COPd or PERd	7.00	– or %
$T_j =$ bivalent temperature	COPd or PERd	1.65	– or %
$T_j =$ operation limit temperature	COPd or PERd	1.65	– or %
For air-to-water heat pumps: $T_j = -15\text{ °C}$ (if TOL < -20°C)	COPd or PERd	x,xx	– or %
For air -to-water heat pumps: Operation limit temperature	TOL	-15	°C
Cycling interval efficiency	COPcyc or PERcyc	x,xx	– or %
Heating water operating limit temperature	WTOL	57	°C

Power consumption in modes other than active mode			
Off mode	P_{OFF}	0.060	kW
Thermostat-off mode	P_{TO}	0.060	kW
Standby mode	P_{SB}	0.060	kW
Crankcase heater mode	P_{CK}	0.050	kW

Supplementary heater			
Rated heat output (*)	P_{sup}	2.2	kW
Type of energy input	Electric		

Other items			
Capacity control	Variable		
Sound power level, indoors/outdoors	$L_{WA,indoor}$	44	dB
	$L_{WA,outdoor}$	66	dB
Annual electricity consumption (Low Temp)	Q HE, (Low Temp)	4804	kWh
Annual electricity consumption (Mid Temp)	Q HE (Mid Temp)	6156	kWh

For air-to-water heat pumps: Rated air flow rate, outdoors (Low Temp)	7200	m ³ /h
For air-to-water heat pumps: Rated air flow rate, outdoors (Mid. Temp)	5160	m ³ /h
For water-/brine-to-water heat pumps: Rated brine or water flow rate, outdoor heat exchanger	x	
Water Pump EEI	≤	0.23
*The benchmark for the most efficient circulators is EEI ≤ 0,20.;		

For heat pump combination heater			
Declared load profile	x		
Daily electricity consumption	Qelec	x,xxx	kWh
Annual electricity consumption	AEC	x	kWh

Water heating energy efficiency	η_{wh}	x	%
Daily fuel consumption	Qfuel	x,xxx	kWh
Annual fuel consumption	AFC	x	GJ

Contact details
 Name : Christianna Papazahariou
 Position : European Regulatory Manager
 E-mail address : chris.papazahariou@lge.com Tel. 01 49 89 57 41 – 06 83 077 455
 Postal address : Paris Nord II – 117 avenue des Nations BP 59372
 Villepinte – 95942 Roissy CDG Cedex
 www.lg.com

(*) For heat pump space heaters and heat pump combination heaters, the rated heat output P_{rated} is equal to the design load for heating $P_{design,h}$, and the rated heat output of a supplementary heater P_{sup} is equal to the supplementary capacity for heating $sup(T_j)$.

(**) If C_{dh} is not determined by measurement then the default degradation coefficient is $C_{dh} = 0,9$.

Warmer climate

Low temperature application

Item	Symbol	Value	Unit
Rated heat output (*)	P_{rated}	10	kW
Declared capacity for heating for part load at indoor temperature 20 °C and outdoor temperature T_j			
$T_j = + 2\text{ °C}$	P_{dh}	10.0	kW
$T_j = + 7\text{ °C}$	P_{dh}	6.4	kW
$T_j = + 12\text{ °C}$	P_{dh}	4.2	kW
$T_j =$ bivalent temperature	P_{dh}	10.0	kW
$T_j =$ operation limit temperature	P_{dh}	10.0	kW
For air-to-water heat pumps: $T_j = -15\text{ °C}$ (if TOL < -20°C)	P_{dh}	x,x	kW
Bivalent temperature	T_{biv}	2	°C
Cycling interval capacity for heating	P_{cych}	x,x	kW
Degradation co-efficient(**)	C_{dh}	0.9	

Item	Symbol	Value	Unit
Seasonal space heating energy efficiency	η_s	222%	
Declared coefficient of performance or primary energy ratio for part load at indoor temperature 20 °C and outdoor temperature T_j			
$T_j = + 2\text{ °C}$	COPd or PERd	3.10	– or %
$T_j = + 7\text{ °C}$	COPd or PERd	5.18	– or %
$T_j = + 12\text{ °C}$	COPd or PERd	7.45	– or %
$T_j =$ bivalent temperature	COPd or PERd	3.10	– or %
$T_j =$ operation limit temperature	COPd or PERd	3.10	– or %
For air-to-water heat pumps: $T_j = -15\text{ °C}$ (if TOL < -20°C)	COPd or PERd	x,xx	– or %
Cycling interval efficiency	COPcyc or PERcyc	x,xx	– or %

Medium temperature application

Item	Symbol	Value	Unit
Rated heat output (*)	P_{rated}	10	kW
Declared capacity for heating for part load at indoor temperature 20 °C and outdoor temperature T_j			
$T_j = + 2\text{ °C}$	P_{dh}	9.9	kW
$T_j = + 7\text{ °C}$	P_{dh}	6.6	kW
$T_j = + 12\text{ °C}$	P_{dh}	3.7	kW
$T_j =$ bivalent temperature	P_{dh}	9.9	kW
$T_j =$ operation limit temperature	P_{dh}	9.9	kW
For air-to-water heat pumps: $T_j = -15\text{ °C}$ (if TOL < -20°C)	P_{dh}	x,x	kW
Bivalent temperature	T_{biv}	2	°C
Cycling interval capacity for heating	P_{cych}	x,x	kW
Degradation co-efficient(**)	C_{dh}	0.9	

Item	Symbol	Value	Unit
Seasonal space heating energy efficiency	η_s	167%	
Declared coefficient of performance or primary energy ratio for part load at indoor temperature 20 °C and outdoor temperature T_j			
$T_j = + 2\text{ °C}$	COPd or PERd	2.36	– or %
$T_j = + 7\text{ °C}$	COPd or PERd	3.40	– or %
$T_j = + 12\text{ °C}$	COPd or PERd	6.30	– or %
$T_j =$ bivalent temperature	COPd or PERd	2.36	– or %
$T_j =$ operation limit temperature	COPd or PERd	2.36	– or %
For air-to-water heat pumps: $T_j = -15\text{ °C}$ (if TOL < -20°C)	COPd or PERd	x,xx	– or %
Cycling interval efficiency	COPcyc or PERcyc	x,xx	– or %

Annual electricity consumption (Low Temp)	$Q_{HE, (Low Temp)}$	2374	kWh
Annual electricity consumption (Mid Temp)	$Q_{HE (Mid Temp)}$	3108	kWh

Colder climate

Low temperature application

Item	Symbol	Value	Unit
Rated heat output (*)	P_{rated}	12	kW
Declared capacity for heating for part load at indoor temperature 20 °C and outdoor temperature T_j			
$T_j = -7\text{ °C}$	P_{dh}	7.3	kW
$T_j = +2\text{ °C}$	P_{dh}	4.4	kW
$T_j = +7\text{ °C}$	P_{dh}	4.1	kW
$T_j = +12\text{ °C}$	P_{dh}	4.6	kW
$T_j =$ bivalent temperature	P_{dh}	7.3	kW
$T_j =$ operation limit temperature	P_{dh}	9.8	kW
For air-to-water heat pumps:			
$T_j = -15\text{ °C}$ (if TOL < -20°C)	P_{dh}	x,x	kW
Bivalent temperature	T_{biv}	-7	°C
Cycling interval capacity for heating	P_{cyc}	x,x	kW
Degradation co-efficient(**)	C_{dh}	0.9	

Item	Symbol	Value	Unit
Seasonal space heating energy efficiency	η_s	122%	
Declared coefficient of performance or primary energy ratio for part load at indoor temperature 20 °C and outdoor temperature T_j			
$T_j = -7\text{ °C}$	COPd or PERd	2.60	or %
$T_j = +2\text{ °C}$	COPd or PERd	4.15	or %
$T_j = +7\text{ °C}$	COPd or PERd	6.10	or %
$T_j = +12\text{ °C}$	COPd or PERd	7.85	or %
$T_j =$ bivalent temperature	COPd or PERd	2.60	or %
$T_j =$ operation limit temperature	COPd or PERd	2.42	or %
For air-to-water heat pumps:			
$T_j = -15\text{ °C}$ (if TOL < -20°C)	COPd or PERd	x,xx	or %
Cycling interval efficiency	COPcyc or PERcyc	x,xx	or %

Medium temperature application

Item	Symbol	Value	Unit
Rated heat output (*)	P_{rated}	12	kW
Declared capacity for heating for part load at indoor temperature 20 °C and outdoor temperature T_j			
$T_j = -7\text{ °C}$	P_{dh}	7.3	kW
$T_j = +2\text{ °C}$	P_{dh}	4.4	kW
$T_j = +7\text{ °C}$	P_{dh}	3.6	kW
$T_j = +12\text{ °C}$	P_{dh}	4.1	kW
$T_j =$ bivalent temperature	P_{dh}	7.3	kW
$T_j =$ operation limit temperature	P_{dh}	9.8	kW
For air-to-water heat pumps:			
$T_j = -15\text{ °C}$ (if TOL < -20°C)	P_{dh}	x,x	kW
Bivalent temperature	T_{biv}	-7	°C
Cycling interval capacity for heating	P_{cyc}	x,x	kW
Degradation co-efficient(**)	C_{dh}	0.9	

Item	Symbol	Value	Unit
Seasonal space heating energy efficiency	η_s	99%	
Declared coefficient of performance or primary energy ratio for part load at indoor temperature 20 °C and outdoor temperature T_j			
$T_j = -7\text{ °C}$	COPd or PERd	2.00	or %
$T_j = +2\text{ °C}$	COPd or PERd	3.15	or %
$T_j = +7\text{ °C}$	COPd or PERd	4.80	or %
$T_j = +12\text{ °C}$	COPd or PERd	6.65	or %
$T_j =$ bivalent temperature	COPd or PERd	2.00	or %
$T_j =$ operation limit temperature	COPd or PERd	1.80	or %
For air-to-water heat pumps:			
$T_j = -15\text{ °C}$ (if TOL < -20°C)	COPd or PERd	x,xx	or %
Cycling interval efficiency	COPcyc or PERcyc	x,xx	or %

Annual electricity consumption (Low Temp)	Q HE, (Low Temp)	9468	kWh
Annual electricity consumption (Mid Temp)	Q HE (Mid Temp)	11611	kWh

(EN) : For the localized language version of the specific precautions that shall be taken when the heater is assembled, installed or maintained, please, find the below link.

(SQ) : Për versionin e lokalizuar të masave specifike që duhet të merren kur ngrohësi është montuar, instaluar ose mirëmbajtur, ju lutemi gjeni lidhjen më poshtë.

(BS) : Za lokalizovanu verziju jezika specifičnih mera predostrožnosti koje treba preduzeti kada se grejač montira, ugradi ili održava, molimo vas da pronađete donji link.

(BG) : За локализираната езикова версия на конкретните предпазни мерки, които трябва да се вземат, когато се монтира, инсталира или поддържа нагревателят, моля, намерете следната връзка.

(HR) : Za lokaliziranu jezičnu inačicu posebnih mjera predostrožnosti koje treba poduzeti kada se grijač montira, instalira ili održava, molimo pronađite vezu u nastavku.

(CS) : Pro lokalizovanou jazykovou verzi konkrétních bezpečnostních opatření, která se mají provést při sestavování, instalaci nebo údržbě ohřívače, naleznete níže uvedený odkaz.

(DA) : For den lokale sprogversion af de specifikke forholdsregler, der skal træffes, når varmeren er monteret, installeret eller vedligeholdt, bedes du finde nedenstående link.

(NL) : Voor de vertaalde taalversie van de specifieke voorzorgsmaatregelen die moeten worden getroffen wanneer de kachel wordt gemonteerd, geïnstalleerd of onderhouden, vindt u de onderstaande link.

(ET) : Keele kokkupanemiseks, paigaldamiseks või hooldamiseks vajalike konkreetsete ettevaatusabinõude kohaliku keele versiooni leiate allolevast linkist.

(FI) : Löytää alla oleva linkki lokalisoituun kieliversiota varten tarvittaviin erityisiin varotoimiin, jotka on otettava, kun lämmitintä asennetaan, asennetaan tai huolletaan.

(FR) : Pour la version localisée de la langue des précautions spécifiques qui doivent être prises lorsque le réchauffeur est assemblé, installé ou entretenu, veuillez trouver le lien ci-dessous.

(DE) : Für die lokalisierte Sprachversion der spezifischen Vorsichtsmaßnahmen, die getroffen werden müssen, wenn die Heizung montiert, installiert oder gewartet wird, finden Sie bitte den folgenden Link.

(EL) : Για την τοπική γλωσσική έκδοση των ειδικών προφυλάξεων που πρέπει να λαμβάνονται κατά τη συναρμολόγηση, την εγκατάσταση ή τη συντήρηση του θερμαντήρα, βρείτε τον παρακάτω σύνδεσμο.

(HU) : A fűtőelem összeszereléséhez, telepítéséhez vagy karbantartásához szükséges különleges óvintézkedések helyi nyelvű változatához kérjük, keresse meg az alábbi linket.

(IS) : Fyrir staðbundna tungumálútgáfu sérstakra varúðarráðstafana sem taka skal þegar hitari er sett saman, settur upp eða viðhaldið, vinsamlegast finndu eftirfarandi tengil.

(GA) : Maidir leis an leagan teanga áitiúil de na réamhchúraimí sonracha a dhéanfar nuair a bhíonn an téitheoir comhdhéanta, suiteáilte nó á chothabháil, féach an nasc thíos.

(IT) : Per la versione in lingua localizzata delle precauzioni specifiche che devono essere prese quando il riscaldatore è assemblato, installato o sottoposto a manutenzione, si prega di trovare il link sottostante.

(LV) : Per la versione in lingua localizzata delle precauzioni specifiche che devono essere prese quando il riscaldatore è assemblato, installato o sottoposto a manutenzione, si prega di trovare il link sottostante.

(LT) : Dėl specifinių atsargumo priemonių, kurios turi būti imamos, kai šildytuvus sumontuojamas, sumontuojamas ar prižiūrimas, lokalizuota kalba versija rasite žemiau esančią nuorodą.

(MK) : За локализирана јазична верзија на конкретните мерки на претпазливост што треба да се преземат кога греачот е составен, инсталиран или одржуван, Ве молиме, пронајдете ја долната врска.

(MT) : Għal verżjoni tal-lingwa lokalizzata tal-prekawżjonijiet speċifiċi li għandhom jittiehdu meta l-heater ikun immuntat, stallat jew miżmum, jekk jogħġbok, sib il-link hawn taħt.

(NO) : For den lokale språkversjonen av de spesielle forholdsreglene som skal tas når varmeapparatet er montert, installert eller vedlikeholdt, vennligst finn lenken nedenfor.

(PL) : W przypadku zlokalizowanej wersji językowej szczególnych środków ostrożności, które należy podjąć po zmontowaniu, zainstalowaniu lub konserwacji grzałki, należy znaleźć poniższy link.

(PT) : Para a versão de idioma localizado das precauções específicas que devem ser tomadas quando o aquecedor é montado, instalado ou mantido, por favor, encontre o link abaixo.

(RO) : Pentru versiunea lingvistică localizată a măsurilor de precauție specifice care trebuie luate atunci când radiatorul este asamblat, instalat sau întreținut, vă rugăm să găsiți linkul de mai jos.

(SR) : За верзију локализованог језика специфичних мера предострожности које треба предузети када се грејач угради, угради или одржи, молимо вас да пронађете доњи линк.

(SK) : Pre lokalizovanú jazykovú verziu špecifických bezpečnostných opatrení, ktoré sa majú vykonať pri zostavovaní, inštalácii alebo údržbe ohrievača, vyhľadajte nižšie uvedený odkaz.

(SL) : Za lokalno jezikovno različico posebnih varnostnih ukrepov, ki jih je treba upoštevati, ko je grelnik sestavljen, nameščen ali vzdrževan, prosimo, poiščite spodnjo povezavo.

(ES) : Para la versión de idioma localizado de las precauciones específicas que se tomarán cuando se ensamble, instale o mantenga el calentador, busque el siguiente enlace.

(SV) : För den lokala språkversionen av de specifika försiktighetsåtgärder som ska vidtas när värmaren monteras, installeras eller underhålls, vänligen hitta nedanstående länk.

<http://www.lg.com/common/index.jsp>

Specific Precautions



To prevent injury to the user or other people and property damage, the following instructions must be followed.

- Be sure to read before installing the unit.
- Be sure to observe the cautions specified here as they include important items related to safety.
- Incorrect operation due to ignoring instruction will cause harm or damage. The seriousness is classified by the following indications.

 **WARNING** This symbol indicates the possibility of death or serious injury.

 **CAUTION** This symbol indicates the possibility of injury or damage to properties only.

- Meanings of symbols used in this manual are as shown below.

	Be sure not to do.
	Be sure to follow the instruction.

 **WARNING**

Installation

- Do not use a defective or underrated circuit breaker. Use this appliance on a dedicated circuit.
 - There is risk of fire or electric shock.
- For electrical work, contact the dealer, seller, a qualified electrician, or an Authorized Service Center.
 - There is risk of fire or electric shock.
- Always ground the unit.
 - There is risk of fire or electric shock.
- Install the panel and the cover of control box securely.
 - There is risk of fire or electric shock.
- Always install a dedicated circuit and breaker.
 - Improper wiring or installation may cause fire or electric shock.
- Use the correctly rated breaker or fuse.
 - There is risk of fire or electric.
- Do not modify or extend the power cable.
 - There is risk of fire or electric shock.
- Do not install, remove, or reinstall the unit by yourself (customer).
 - There is risk of fire, electric shock, explosion, or injury.

-
- For antifreeze, always contact the dealer or an authorized service center.
 - Almost the antifreeze is a toxic product.
 - For installation, always contact the dealer or an Authorized Service Center.
 - There is risk of fire, electric shock, explosion, or injury.
 - Do not install the unit on a defective installation stand.
 - It may cause injury, accident, or damage to the unit.
 - Be sure the installation area does not deteriorate with age.
 - If the base collapses, the unit could fall with it, causing property damage, unit failure, and personal injury.
 - Do not install the water pipe system as Open loop type.
 - It may cause failure of unit.
 - Use a vacuum pump or inert (nitrogen) gas when doing leakage test or purging air. Do not compress air or oxygen and do not use flammable gases.
 - There is the risk of death, injury, fire or explosion.
 - Make sure the connected condition of connector in product after maintenance.
 - Otherwise, it may cause product damage.
 - Do not touch leaked refrigerant directly.
 - There is risk of frostbite.

Operation

- Take care to ensure that power cable could not be pulled out or damaged during operation.
 - There is risk of fire or electric shock.
 - Do not place anything on the power cable.
 - There is risk of fire or electric shock.
 - Do not plug or unplug the power supply plug during operation.
 - There is risk of fire or electric shock.
 - Do not touch (operate) the unit with wet hands.
 - There is risk of fire or electric shock.
 - Do not place a heater or other appliances near the power cable.
 - There is risk of fire or electric shock.
 - Do not allow water to run into electric parts.
 - There is risk of fire, failure of the unit, or electric shock.
-

-
- Do not store or use flammable gas or combustibles near the unit.
 - There is risk of fire or failure of unit.
 - Do not use the unit in a tightly closed space for a long time.
 - It may cause damage to the unit.
 - When flammable gas leaks, turn off the gas and open a window for ventilation before turning the unit on.
 - There is risk of explosion or fire.
 - If strange sounds, or small or smoke comes from unit, turn the breaker off or disconnect the power supply cable.
 - There is risk of electric shock or fire.
 - Stop operation and close the window in storm or hurricane. If possible, remove the unit from the window before the hurricane arrives.
 - There is risk of property damage, failure of unit, or electric shock.
 - Do not open the front cover of the unit while operation. (Do not touch the electrostatic filter, if the unit is so equipped.)
 - There is risk of physical injury, electric shock, or unit failure.
 - Do not touch any electric part with wet hands. you should be power off before touching electric part.
 - There is risk of electric shock or fire.
 - Do not touch refrigerant pipe and water pipe or any internal parts while the unit is operating or immediately after operation.
 - There is risk of burns or frostbite, personal injury.
 - If you touch the pipe or internal parts, you should be wear protection or wait time to return to normal temperature.
 - Otherwise , it may cause burns or frostbite, personal injury.
 - Turn the main power on 6 hours ago before the product starting operation.
 - Otherwise, it may cause compressor damage.
 - Do not touch electric parts for 10 minutes after main power off.
 - There is risk of physical injury, electric shock.
 - The inside heater of product may operate during stop mode. It is intended to protect the product.
 - Be careful that some part of the control box are hot.
 - There is risk of physical injury or burns.
 - When the unit is soaked (flooded or submerged), contact an Authorized Service Center.
 - There is risk of fire or electric shock.
-

-
- Be cautious that water could not be poured to the unit directly.
 - There is risk of fire, electric shock, or unit damage.
 - Ventilate the unit from time to time when operating it together with a stove, etc.
 - There is risk of fire or electric shock.
 - Turn the main power off when cleaning or maintaining the unit.
 - There is risk of electric shock.
 - Take care to ensure that nobody could step on or fall onto the unit.
 - This could result in personal injury and unit damage.
 - For installation, always contact the dealer or an Authorized Service Center.
 - There is risk of fire, electric shock, explosion, or injury.
 - If the unit is not used for long time, we strongly recommend not to switch off the power supply to the unit.
 - There is risk of water freezing.
-

 **CAUTION**

Installation

- Always check for gas (refrigerant) leakage after installation or repair of unit.
 - Low refrigerant levels may cause failure of unit.
- Keep level even when installing the unit.
 - To avoid vibration or water leakage.
- Use two or more people to lift and transport the unit.
 - Avoid personal injury.

Operation

- Do not use the unit for special purposes, such as preserving foods, works of art, etc.
 - There is risk of damage or loss of property.
 - Use a soft cloth to clean. Do not use harsh detergents, solvents, etc.
 - There is risk of fire, electric shock, or damage to the plastic parts of the unit.
 - Do not step on or put anything on the unit.
 - There is risk of personal injury and failure of unit.
 - Use a firm stool or ladder when cleaning or maintaining the unit.
 - Be careful and avoid personal injury.
 - Do not turn on the breaker or power under condition that front panel, cabinet, top cover, control box cover are removed or opened.
 - Otherwise, it may cause fire, electric shock, explosion or death.
-

Maintenance

Maintenance Activities

In order to ensure optimal availability of the unit, a number of checks and inspections on the unit and the field wiring have to be carried out at regular intervals, preferably yearly. This maintenance should be carried out by your local agreed technician.

When the unit is not going....

⚠ CAUTION

- If the product is not used for long time, we strongly recommend NOT TO SWITCH OFF THE POWER SUPPLY to the product.
- If power is not supplied, some special product-protecting actions (such as water pump anti-locking) will not performed.

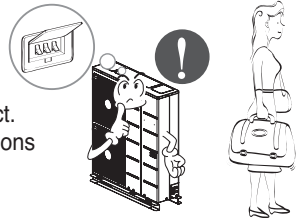

Call the service immediately in the following situations

1. Anything abnormal such as burning smell, loud noise etc. happen. Stop the unit and turn the breaker off. Never try to repair by yourself or restart the system in such cases.
2. Main power cord is too hot or damaged.
3. Error code is generated by self diagnosis.
4. Water leaks from unit.
5. Any switch, breaker (safety, earth) or fuse fails to work properly.

User must carry routine checkup & cleaning to avoid unit's poor performance.

In case of special situation, the job must be carried out by the only service person.

⚠ CAUTION

- In the case of water with added brine, the drain valve of shut-off valve must be connected to a recovery container.
 - Do not touch the water stirred with the brine.
 - When the brine in the pipe is leaked, do not operate the unit and contact dealer, seller or an authorized service center.
-

Information relevant for recycling and/or disposal at end-of-life

ENGLISH



Disposal of your old appliance

- 1 This crossed-out wheeled bin symbol indicates that waste electrical and electronic products (WEEE) should be disposed of separately from the municipal waste stream.
- 2 Old electrical products can contain hazardous substances so correct disposal of your old appliance will help prevent potential negative consequences for the environment and human health. Your old appliance may contain reusable parts that could be used to repair other products, and other valuable materials that can be recycled to conserve limited resources.
- 3 You can take your appliance either to the shop where you purchased the product, or contact your local government waste office for details of your nearest authorised WEEE collection point. For the most up to date information for your country please see www.lg.com/global/recycling

БЪЛГАРСКИ



Изхвърляне на стария уред

- 1 Символът със зачертаня контейнер показва, че отпадъците от електрическите и електронните продукти (WEEE) трябва да се изхвърлят отделно от битовите отпадъци.
- 2 Старите електрически продукти могат да съдържат опасни вещества и правилното изхвърляне на Вашия уред ще помогне за предотвратяване на негативните последици за околната среда и човешкото здраве. Вашият стар уред може да съдържа части за многократна употреба, които биха могли да бъдат използвани за ремонт на други продукти, както и други ценни материали, които могат да бъдат рециклирани с цел запазване на ограничените ресурси.
- 3 Можете да занесете Вашия уред или в магазина, от който сте го закупили или можете да се свържете с местния държавен офис за отпадъците, за да получите информация за най-близкия РАЗРЕШЕН WEEE пункт за събиране на отпадъци. За най-актуална информация от Вашата държава, моля, погледнете тук: www.lg.com/global/recycling

HRVATSKI



Zbrinjavanje starog uređaja

- 1 Ovaj simbol prekrizene kante za smeće na kotačicama označava kako se otpadni električni i električni proizvodi (WEEE) moraju zbrinjavati odvojeno od komunalnog otpada.
- 2 Dotrajali električni proizvodi mogu sadržavati opasne tvari stoga će ispravno zbrinjavanje vaših dotrajalih uređaja pomoći u sprječavanju potencijalnih negativnih posljedica na okoliš i ljudsko zdravlje. Vaš dotrajaao uređaj može sadržavati dijelove koji se mogu ponovo iskoristiti za popravak drugih proizvoda te druge vrijedne materijale koji se mogu reciklirati i tako sačuvati ograničene resurse.
- 3 Ovisno o razini smetnje / štete i dobi stavke, stari proizvodi mogu se popraviti za više radnog života koji će spriječiti izbjeci otpada. Proizvodi koji nisu prikladni za ponovnu uporabu može se reciklirati da se oporavim vrijedne resurse i pomoći da se smanji globalno potrošnju novih sirovina.
- 4 Uređaj možete odnijeti u trgovinu u kojoj ste kupili proizvod ili možete kontaktirati ured za zbrinjavanje otpada kod vaših mjesnih nadležnih tijela te od njih saznati više informacija o najbližem ovlaštenom WEEE sabirnom centru. Za najnovije informacije iz vaše države molimo pogledajte internetske stranice www.lg.com/global/recycling

ČESKY



Likvidace starého přístroje

- 1 Tento symbol přeškrtnutého koše značí, že odpad z elektrických a elektronických výrobků (WEEE) je nutné likvidovat odděleně od linky komunálního odpadu.
- 2 Staré elektrické výrobky mohou obsahovat nebezpečné látky, takže správná likvidace starých přístrojů pomůže zabránit potenciálním negativním důsledkům pro životní prostředí a lidské zdraví. Staré přístroje mohou obsahovat znovu použitelné díly, které lze použít k opravě dalších výrobků a další cenné materiály, které lze recyklovat a šetřit tak omezené zdroje.
- 3 Přístroj můžete zanešt buď do obchodu, kde jste ho zakoupili nebo se obrátit na místní správu komunálních odpadů, kde získáte podrobné informace o autorizovaném sběrném místě WEEE. Pro poslední aktuální informace z vaší země si prosím prostudujte web www.lg.com/global/recycling

DANSK



Bortskaffelse af dit gamle apparat

- 1 Dette symbol med en affaldsspand med kryds over angiver at elektrisk og elektronisk affald (WEEE) skal bortskaffes og genbruges korrekt, adskilt fra kommunens husholdningsaffald.
- 2 Gamle elektriske produkter kan indeholde farlige stoffer, så når du bortskaffer dit gamle apparat på korrekt vis, hjælper du med at forhindre mulige negative konsekvenser for miljø og mennesker. Dit gamle apparat kan indeholde dele som kan genbruges, fx til at reparere andre produkter, eller værdifulde materialer som kan genbruges og derved begrænse spild af værdifulde ressourcer.
- 3 Du kan enten tage apparatet til den butik hvor du købte det, eller kontakte dit lokale affaldskontor angående oplysninger om det nærmeste, autoriserede WEEE-samlingspunkt. Find de sidste nye oplysninger for dit land på www.lg.com/global/recycling.

EESTI



Teie vana seadme hävitamine

- 1 Läbitõmmatud ristiga prügikasti sümbol tähendab, et elektriliste ja elektrooniliste toodete (WEEE) jäätmeid tuleb olmeprügist eraldi hävitada.
- 2 Vanad elektriseadmed võivad sisaldada ohtlikke koostisosi, seega aitab prügi nõuetekohane hävitamine vältida võimalikku negatiivset mõju loodusele ja inimeste tervisele. Teie kasutatud seade võib sisaldada taaskasutatavaid osi, millega saab parandada teisi seadmeid ning muid väärtuslikke materjale, mida saab taaskasutada, et säilitada piiratud ressursse.
- 3 Saate viia oma seadme kas kauplusse, kust see on ostetud või võtta ühendust kohaliku prügiveo ettevõttega, et saada lisainfot oma lähima WEEE jäätmete kogumiskoha kohta. Kõige ajakohasemat infot oma riigi kohta vaadake www.lg.com/global/recycling

SUOMI



Vanhan laitteesi hävittäminen

- 1 Tämä yliristitettu jätteenä merkki ilmaisee, että sähkö- ja elektroniikkalaitteiden jätteet (WEEE) tulee pitää erillään kotitalousjätteestä ja viedä kunnalliseen kierrätyskeskukseen.
- 2 Vanhat sähkötuotteet voivat pitää sisällään vaarallisia aineita, joten loppuun käytetyn laitteen oikea hävittäminen ehkäisee ympäristö- ja terveyshaittoja. Vanha laitteesi saattaa pitää sisällään uudelleen käytettäviä osia, joita voidaan käyttää korjaamaan muita tuotteita sekä arvokkaita materiaaleja, joita voidaan kierrättää rajoitettujen resurssien säästämiseksi.
- 3 Voit viedä laitteesi joko liikkeeseen, josta hankit laitteen, tai ottaa yhteyttä paikallishallintosi ympäristötoimistoon koskien lähintä valtuutettua WEEE -keräyspistettä. Kaikkein viimeisimmät tiedot koskien maatasi, ks. osoitteessa www.lg.com/global/recycling

FRANÇAIS



Recyclage de votre ancien appareil

- 1 Ce symbole de poubelle barrée d'une croix indique que votre équipement électrique et électronique (EEE) ne doit pas être jeté avec les ordures ménagères. Il doit faire l'objet d'un tri et d'une collecte sélective séparée.
- 2 Les équipements électriques que vous jetez peuvent contenir des substances dangereuses. Il est donc important de les jeter de façon appropriée afin d'éviter des impacts négatifs sur l'environnement et la santé humaine. L'équipement que vous jetez peut également contenir des pièces réutilisables pour la réparation d'autres produits ainsi que des matériaux précieux pouvant être recyclés pour préserver les ressources de la planète.
- 3 Vous pouvez rapporter votre appareil au commerçant qui vous l'a vendu ou contacter votre collectivité locale pour connaître les points de collecte de votre EEE. Vous trouverez également des informations à jour concernant votre pays en allant sur www.quefairedemesdechets.fr

DEUTSCH



Entsorgung Ihrer Altgeräte

- 1 Das durchgestrichene Symbol eines fahrbaren Abfallbehälters weist darauf hin, dass Elektro- und Elektronik-Produkte (WEEE) getrennt vom Hausmüll entsorgt werden müssen.
- 2 Alte elektrische Produkte können gefährliche Substanzen enthalten, die eine korrekte Entsorgung dieser Altgeräte erforderlich machen, um schädliche Auswirkungen auf die Umwelt und die menschliche Gesundheit zu vermeiden. Ihre ausgedienten Geräte können wiederverwendbare Teile enthalten, mit denen möglicherweise andere Produkte repariert werden können, aber auch sonstige wertvolle Materialien enthalten, die zur Schonung knapper Ressourcen recycelt werden können.
- 3 Sie können Ihr Gerät entweder in den Laden zurückbringen, in dem Sie das Produkt ursprünglich erworben haben oder Sie kontaktieren Ihre Gemeindeabfallstelle für Informationen über die nächstgelegene autorisierte WEEE Sammelstelle. Die aktuellsten Informationen für Ihr Land finden Sie unter www.lg.com/global/recycling

ΕΛΛΗΝΙΚΑ



Απόρριψη της παλιάς σας συσκευής

- 1 Αυτό το διαγραμμένο σύμβολο του τροχοφόρου κάδου υποδεικνύει ότι τα απόβλητα ηλεκτρικών και ηλεκτρονικών προϊόντων (ΑΗΗΕ) πρέπει να απορρίπτονται χωριστά από τα γενικά οικιακά απορρίμματα.
- 2 Τα παλιά ηλεκτρικά προϊόντα μπορεί να περιέχουν επικίνδυνες ουσίες και ως εκ τούτου η σωστή απόρριψη της παλιάς σας συσκευής αποτρέπει ενδεχόμενες αρνητικές συνέπειες για το περιβάλλον και την ανθρώπινη υγεία. Η παλιά σας συσκευή μπορεί να περιέχει επαναχρησιμοποιήσιμα ανταλλακτικά που θα μπορούσαν να χρησιμοποιηθούν για την επισκευή άλλων προϊόντων, καθώς και άλλα υλικά αξίας που μπορούν να ανακυκλωθούν για εξοικονόμηση των περιορισμένων φυσικών πόρων.
- 3 Μπορείτε να πάτε τη συσκευή σας, είτε στο κατάστημα από το οποίο αγοράσατε το προϊόν, ή να επικοινωνήσετε το τοπικό γραφείο απορριμμάτων για λεπτομέρειες σχετικά με το πλησιέστερο εγκεκριμένο σημείο συλλογής ΑΗΗΕ (Απόβλητα Ηλεκτρικών και Ηλεκτρονικών Συσκευών). Για τις πιο πρόσφατες πληροφορίες για τη χώρα σας επισκεφθείτε τη διεύθυνση www.lg.com/global/recycling

MAGYAR



A régi készülék ártalmatlanítása

- 1 A leselejtezett elektromos és elektronikai termékeket a háztartási hulladéktól elkülönítve kell begyűjteni, a [jogszabályok](#) által kijelölt módon és helyen.
- 2 Régi készülékeinek megfelelő leselejtezése segíthet megelőzni az esetleges egészségre vagy környezetre ártalmas hatásokat.
- 3 Ha további információra van szüksége régi készülékeinek leselejtezésével kapcsolatban, lépjen kapcsolatba velünk a szelektalok.hu oldalon ahol tájékoztatjuk Önt visszavételi, átvételi, gyűjtési és kezelési kötelezettségeinkről.

ITALIANO



Smaltimento delle apparecchiature obsolete

- 1 Tutte le apparecchiature elettriche ed elettroniche, contrassegnate da questo simbolo ("bidone della spazzatura barrato da una croce"), devono essere raccolte e smaltite separatamente rispetto agli altri rifiuti urbani misti mediante impianti di raccolta specifici installati da enti pubblici o dalle autorità locali. Si ricorda che gli utenti finali domestici possono consegnare gratuitamente le apparecchiature elettriche ed elettroniche a fine vita presso il punto vendita all'atto dell'acquisto di una nuova apparecchiatura equivalente. Gli utenti finali domestici possono inoltre consegnare gratuitamente apparecchiature elettriche ed elettroniche di piccolissime dimensioni (non eccedenti i 25 cm) a fine vita direttamente presso un punto vendita a ciò abilitato, senza obbligo di acquistare una apparecchiatura nuova di tipo equivalente. Si prega di informarsi previamente presso il punto vendita prescelto circa tale ultima modalità di conferimento dell'apparecchiatura a fine vita.
- 2 Il corretto smaltimento dell'unità obsoleta contribuisce a prevenire possibili conseguenze negative sulla salute degli individui e sull'ambiente. Una gestione responsabile del fine vita delle apparecchiature elettriche ed elettroniche da parte degli utenti contribuisce al riutilizzo, al riciclaggio ed al recupero sostenibile dei prodotti obsoleti e dei relativi materiali.
- 3 Per informazioni più dettagliate sullo smaltimento delle apparecchiature obsolete, contattare l'ufficio del comune di residenza, il servizio di smaltimento rifiuti o il punto vendita in cui è stato acquistato il prodotto.
(www.lg.com/global/recycling)

ҚАЗАҚША



Ескі құрылғыны қоқысқа тастау

- 1 Бұл осы үсті сызылған шелек таңбасы қоқыс электр және электрондық өнімдер (WEEE) қалалық қоқыс жүйесінен бөлек жойылуы керектігін білдіреді.
- 2 Ескі электр құрылғыларында зиянды заттар болады, сондықтан ескі құрылғыны тиісті түрде қоқысқа тастау қоршаған орта мен адам денсаулығына тиюі мүмкін кері әсерлердің алдын алуға көмектеседі. Ескі құрылғыңызда басқа өнімдерді және шектеулі ресурстарды сақтау қайта өңделетін маңызды материалдарды жөндеу үшін қолданылатын қайта қолданбалы бөлшектер болуы мүмкін.
- 3 Құрылғыңызды өнімді сатып алған дүкенге апаруға немесе жақын жердегі өкілетті WEEE жинау нүктесі туралы мәліметтер үшін жергілікті басқару мекемесіне хабарласуға болады. Еліңіз үшін ең соңғы ақпаратты алу үшін www.lg.com/global/recycling веб-сайтын қараңыз

LATVIEŠU



Jūsu vecās ierīces likvidēšana

- 1 Šis simbols – pārsvītrotā atkritumu tvertne uz rītniem – norāda, ka elektrisko un elektronisko iekārtu atkritumi (EEIA) jālikvidē atsevišķi no sadzīves atkritumu plūsmas.
- 2 Veci elektriskie izstrādājumi var saturēt bīstamas vielas, tādēļ jūsu vecās ierīces pareiza likvidēšana palīdzēs novērst iespējamās negatīvās sekas videi un cilvēka veselībai. Jūsu vecā ierīce var saturēt vairākkārt izmantojamas detaļas, kuras var izmantot citu izstrādājumu remontam, un citus vērtīgus materiālus, kurus var pārstrādāt, tādējādi saglabājot ierobežotus resursus.
- 3 Jūs varat aiznest ierīci vai nu uz veikalu, kurā šo izstrādājumu iegādājāties, vai sazināties ar vietējās pašvaldības atkritumu savākšanas iestādi un uzzināt sīkāku informāciju par tuvāko oficiālo EEIA savākšanas punktu. Jaunāko informāciju par savu valsti skatiet vietnē www.lg.com/global/recycling

LIETUVIŲ K.



Seno prietaiso utilizavimas

- 1 Išbrauktos šiukšlių dėžės simbolis rodo, kad elektros ir elektronikos įrangos atliekos (EEIA) turėtų būti utilizuojamos atskirai nuo komunalinių atliekų.
- 2 Senoje elektrinėje įrangoje gali būti pavojingų medžiagų, taigi tinkamas seno prietaiso utilizavimas padės apsaugoti nuo galimų neigiamų pasekmių aplinkai ir žmonių sveikatai. Jūsų sename prietaise gali būti dalių, kurias galima panaudoti dar kartą taisant kitą įrangą ir kitų vertingų medžiagų, kuriuos gali būti perdirbamos siekiant tausoti ribotus išteklius.
- 3 Savo prietaisą galite nugabenti į parduotuvę, kurioje įrangą įsigijote, arba susisieki su vietos valdžios atliekų tarnyba norėdami gauti artimiausio EEIA surinkimo vietos informaciją. Norėdami gauti daugiau informacijos savo šalyje, apsilankykite www.lg.com/global/recycling

NEDERLANDS



Verwijdering van uw oude apparaat

- 1 Dit symbool van de doorgesloten vuilnisbak geeft aan dat afgedankte elektrische en elektronische producten (WEEE) afzonderlijk van het huishoudelijke afval moeten worden verwijderd.
- 2 Oude elektrische producten kunnen gevaarlijke stoffen bevatten, dus een juiste verwijdering van uw oude apparaat helpt bij het voorkomen van mogelijke negatieve gevolgen voor het milieu en de volksgezondheid. Uw oude apparaat kan herbruikbare onderdelen bevatten die gebruikt zouden kunnen worden voor het repareren van andere producten, en andere waardevolle materialen die kunnen worden gerecycled voor het behoud van beperkte grondstoffen.
- 3 U kunt uw apparaat meenemen naar de winkel waar u het product hebt gekocht, of u kunt contact opnemen met uw plaatselijke afvalinstantie voor de gegevens van uw dichtstbijzijnde geautoriseerde WEEE-verzamelpunt. Voor de meest geactualiseerde informatie voor uw land wordt verwezen naar www.lg.com/global/recycling

NORSK



Avhending av gamle apparater

- 1 Dette symbolet av en utkrysset avfallsdunk indikerer at kasserte elektriske og elektroniske produkter (WEEE) skal kastes separat fra husholdningsavfall og leveres til den kommunale resirkulering.
- 2 Gamle elektriske produkter kan inneholde farlige stoffer, så korrekt avfallshåndtering av det gamle apparatet bidrar til å hindre potensielt negative konsekvenser for miljøet og andres helse. Gamle apparater kan inneholde gjenbrukbare deler som kan brukes til å reparere andre produkter og andre verdifulle materialer som kan resirkuleres for å bevare begrensede ressurser.
- 3 Du kan bringe apparatet enten til butikken der du kjøpte produktet, eller ta kontakt med den lokale myndighetens avfallskontor for informasjon om nærmeste autoriserte innsamlingspunkt for el-avfall (WEEE-avfall). For den mest oppdaterte informasjonen for ditt land, gå til www.lg.com/global/recycling

POLSKI



Utylizacja starego urządzenia

- 1 Symbol przekreślonego pojemnika na odpady na kómkach oznacza, że produkty elektryczne lub elektroniczne (WEEE) należy zutylizować poza obiegiem odpadów komunalnych.
- 2 Stare produkty elektroniczne mogą zawierać niebezpieczne substancje. Właściwa utylizacja starego urządzenia pozwoli uniknąć potencjalnych negatywnych skutków dla środowiska i zdrowia. Stare urządzenie może zawierać części wielokrotnego użytku, które mogą zostać wykorzystane do naprawy innych produktów lub inne wartościowe materiały, które można przetworzyć, aby oszczędzać zasoby naturalne.
- 3 Możesz zanieść urządzenie do sklepu, w którym zostało kupione lub skontaktować się z lokalnym urzędem gospodarki odpadami, aby uzyskać informacje o najbliższym punkcie zbiórki WEEE. Aby uzyskać aktualne informacje z zakresu gospodarki odpadami obowiązującej w Twoim kraju, odwiedź stronę <http://www.lg.com/global/sustainability/environment/take-back-recycling/global-network-europe> (plik PDF : „For more information about how to recycle LG products in your country“.

PORTUGUÊS



Eliminação do seu aparelho usado

- 1 Este símbolo de um caixote do lixo com rodas e linhas cruzadas sobrepostas indica que os resíduos de produtos elétricos e eletrônicos (WEEE) devem ser eliminados separadamente do lixo doméstico.
- 2 Os produtos elétricos usados podem conter substâncias perigosas, pelo que, a eliminação correta do seu aparelho usado pode contribuir para evitar potenciais danos para o ambiente e saúde humana. O seu aparelho usado pode conter peças reutilizáveis que podem ser usadas para reparar outros aparelhos e materiais úteis que podem ser reciclados para preservar os recursos limitados.
- 3 Pode levar o seu aparelho à loja onde o adquiriu ou contactar a sua entidade local de recolha e tratamento de resíduos para obter mais informações sobre o ponto de recolha WEEE autorizado mais próximo. Para obter informações mais atualizadas relativas ao seu país, visite www.lg.com/global/recycling

ROMÂNĂ



Eliminarea aparatului vechi

- 1 Simbolul de pebeală indică faptul că deșeurile electrice și electronice (WEEE) trebuie eliminate separat de celelalte deșeuri.
- 2 Produsele electrice și electronice vechi conțin substanțe periculoase. Astfel, prin eliminarea corespunzătoare veți contribui la prevenirea deteriorării mediului înconjurător și al sănătății umane. Este posibil ca dispozitivul dvs. vechi să conțină piese componente, care pot fi folosite pentru repararea altor produse sau materiale importante care pot fi reciclate în scopul economisirii resurselor limitate.
- 3 Dispozitivul vechi poate fi returnat magazinului de unde a fost achiziționat, sau puteți contacta firma responsabilă pentru eliminarea deșeurilor, în scopul aflării locației unității autorizate pentru reciclarea deșeurilor electrice și electronice (WEEE). Pentru informații mereu actualizate și referitoare la țara dvs. vă rugăm vizitați pagina web www.lg.com/global/recycling

SRPSKI



Odlaganje starog aparata

- 1 Ovaj simbol precrtna kanta za smeće pokazuje da električni i elektronski otpad (WEEE) treba da se odlaže odvojeno od običnog komunalnog otpada.
- 2 Stari električni aparati mogu da sadrže otrovne supstance, tako da će pravilno odlaganje Vašeg starog aparata pomoći sprečavanju pojave negativnih posledica po životnu sredinu i zdravlje ljudi. Vaš stari aparat može da sadrži delove za višekratnu upotrebu koji se mogu koristiti za zamenu drugih proizvoda i druge vredne materijale koji se mogu reciklirati radi očuvanja ograničenih resursa.
- 3 Vaš aparat možete da odnesete u radnju gde ste ga kupili ili da kontaktirate lokalnu vladinu kancelariju za otpad kako biste dobili informaciju o najbližoj autorizovanoj WEEE stanici za odlaganje ovog otpada. Za najnovije informacije za Vašu zemlju, molimo Vas da pogledate web stranicu www.lg.com/global/recycling

SLOVENČINA



Zneškodnenie starého spotrebiča

- 1 Tento symbol prečiarknutého odpadkového koša na kolieskach znamená, že odpad z elektrických a elektronických zariadení (WEEE) musí byť zneškodnený samostatne od komunálneho odpadu.
- 2 Staré elektrické produkty môžu obsahovať nebezpečné latky, preto správne zneškodnenie vášho starého spotrebiča pomôže zabrániť potenciálnym negatívnym dopadom na prostredie a ľudské zdravie. Váš starý spotrebič môže obsahovať diely, ktoré možno opätovne použiť na opravu iných produktov, a iné cenné materiály, ktoré možno recyklovať s cieľom chrániť obmedzené zdroje.
- 3 Svoj spotrebič môžete zniesť do predajne, kde ste produkt zakúpili, alebo sa môžete obrátiť na oddelenie odpadov miestnej samosprávy a požiadať o informácie o najbližšom zbernom mieste odpadu z elektrických a elektronických zariadení (WEEE). Najnovšie informácie platné pre vašu krajinu nájdete na stránke www.lg.com/global/recycling

SLOVENŠČINA



Odstranjevanje vašega starega aparata

- 1 Na izdelku precrtn simbol smetnjaka opozarja, da je treba odpadne električne in elektronske izdelke (OEEI) odstranjevati ločeno od ostalih komunalnih odpadkov.
- 2 Odpadni električni izdelki lahko vsebujejo nevarne snovi, zato s pravilnim odstranjevanjem starega aparata pripomorete k preprečevanju morebitnih negativnih vplivov na okolje in zdravje ljudi. Vaš stari aparat lahko vsebuje dele, ki bi jih bilo mogoče uporabiti za popravilo drugih izdelkov, in druge dragocene materiale, ki jih je mogoče reciklirati in s tem ohranjati omejene vire.
- 3 Vaš aparat lahko odnesete bodisi v trgovino, kjer ste kupili ta izdelek, ali pa se obrnite na lokalni urad za odstranjevanje odpadkov glede podrobnosti o najbližjem pooblaščenem zbirnem mestu za OEEI. Za najnovejše informacije za vašo državo si oglejte www.lg.com/global/recycling

ESPAÑOL



Símbolo para marcar AEE

- 1 El símbolo del contenedor de basura tachado con un aspa indica que la recogida separada de aparatos eléctricos y electrónicos (AEE) debe realizarse de manera separada.
- 2 Los productos eléctricos antiguos pueden contener sustancias peligrosas de modo que la correcta eliminación del antiguo aparato ayudará a evitar posibles consecuencias negativas para el medio ambiente y para la salud humana. El antiguo aparato puede contener piezas reutilizables que podrían utilizarse para reparar otros productos y otros materiales valiosos que pueden reciclarse para conservar los recursos limitados.
- 3 Puede llevar el aparato a cualquiera de los centros autorizados para su recogida. Para obtener la información más actualizada para su país por favor visite www.lg.com/global/recycling

SVENSKA



Kassera den gamla apparaten

- 1 Den överkorsade soptunnesymbolen indikerar att elektroniskt och elektriskt avfall (WEEE) ska kasseras separat från hushållsavfallet och lämnas in till av kommunen anvisat ställe för återvinning.
- 2 Gamla elektroniska och elektriska produkter kan innehålla farliga substanser så korrekt avfallshantering av produkten förhindrar negativa konsekvenser för miljön och den mänskliga hälsan. Din gamla apparat kan innehålla återanvändningsbara delar som används för att reparera andra produkter och andra värdefulla material som kan återvinnas för att spara begränsade resurser.
- 3 Du kan ta din gamla apparat till butiken där du köpte produkten, eller kontakta din kommun för information om närmaste WEEE-uppsamlingsställe. För den mest uppdaterade informationen i ditt land, gå till www.lg.com/global/recycling

РУССКИЙ



Утилизация старого оборудования

- 1 Этот перечеркнутый символ мусорной корзины указывает на то, что отработанные электрические и электронные изделия (WEEE) следует утилизировать отдельно от бытовых отходов.
- 2 Старые электрические изделия могут содержать опасные вещества, поэтому правильная утилизация старого оборудования поможет предотвратить возможные негативные последствия для окружающей среды и здоровья человека. Старое оборудование может содержать детали, которые могут быть повторно использованы для ремонта других изделий, а также другие ценные материалы, которые можно переработать, чтобы сохранить ограниченные ресурсы.
- 3 Вы можете отнести свой прибор в магазин, где он был приобретен, либо связаться с органами местного самоуправления для получения подробных сведений о ближайшем пункте приема отходов электрического и электронного оборудования (WEEE). Для получения самой свежей информации относительно вашей страны обращайтесь по адресу: www.lg.com/global/recycling

TÜRKÇE



Eski cihazınızın atılması

- 1 Tüm elektrikli ve elektronik atıklar, devlet ya da yerel yetkililer tarafından belirlenen toplama merkezlerinde ayrı olarak imha edilmelidir. Atık elektrikli ve elektronik aletler belediyeler tarafından kurulan toplama noktalarına teslim edilmeli veya aldığınız yeni ürünü satıcınıza teslim ederken, satıcınızdan atık elektrikli ve elektronik aletinizi teslim almasını istemelisiniz.
- 2 Atık ürünün doğru imhası çevre ve insan sağlığı üzerindeki potansiyel olumsuz sonuçların engellenmesine yardımcı olacaktır.
- 3 Eski ürününüzün imhası hakkında daha fazla bilgi için lütfen belediyeniz ya da ürünü aldığınızı mağaza ile iletişime geçiniz.
- 4 AEEE Yönetmeliğine Uygundur.
- 5 Bu işareti içeren ürünler tehlikeli madde içerebilir. Ürünler içerisindeki tehlikeli maddeler çevre kirlenmesine veya yaralanma/ölüme sebebiyet verebilir. (www.lg.com/global/recycling)

УКРАЇНСЬКА



Утилізація старого обладнання

- 1 Цей перекреслений символ смітєвого кошика вказує, що відпрацьовані електричні та електронні вироби (WEEE) потрібно утилізувати окремо від побутових відходів.
- 2 Старі електричні вироби можуть містити небезпечні речовини, тому правильна утилізація старого обладнання допоможе запобігти можливим негативним наслідкам для навколишнього середовища та здоров'я людини. Старе обладнання може містити деталі, які можуть бути використані повторно для ремонту інших виробів, а також інші цінні матеріали, які можливо переробити, щоб зберегти обмежені ресурси.
- 3 Ви можете віднести свій прилад в магазин, де його було придбано, або зв'язатися з органами місцевого самоврядування, щоб отримати докладні відомості про найближчий пункт прийому відходів електричного та електронного обладнання (WEEE). Щоб отримати найсвіжішу інформацію щодо вашої країни, звертайтеся за адресою: www.lg.com/global/recycling

DISASSEMBLY GUIDE

"Attention! Users should never attempt disassembly on their own! Please contact a professional!"

(EN) : "Attention! Users should never attempt disassembly on their own! Please contact a professional!"
(SQ) : "Kujdes! Përdoruesit kurrë nuk duhet të përpiqen të çlirojnë vetë! Ju lutem kontaktoni një profesionist!"
(BS) : "Pažnja! Korisnici nikada ne bi trebali pokušati demontažu sami! Molimo kontaktirajte profesionalca!"
(BG) : "Внимание! Потребителите никога не трябва да се опитват да демонтират сами!
(HR) : "Pažnja! Korisnici nikada ne bi smjeli sami pokušavati rastavljanje! Obratite se profesionalcu!"
(CS) : "Pozor! Uživatelé by se nikdy neměli pokoušet demontovat samy o sobě!
(DA) : "OBS! Brugere bør aldrig forsøge demontering på egen hånd! Kontakt venligst en professionel!"
(NL) : "Let op! Gebruikers mogen nooit zelf demonteren! Neem contact op met een professional!"
(ET) : "Tähelepanu! Kasutajad ei tohiks kunagi proovida lahti monteerida!" Palun võtke ühendust professionaaliga!"
(FI) : "Huomio! Käyttäjät eivät saa koskaan yrittää purkaa itseään! Ota yhteyttä ammattilaiseen!"
(FR) : "Attention! Les utilisateurs ne doivent jamais essayer de démonter par eux-mêmes! Veuillez contacter un professionnel!"
(DE) : "Achtung! Benutzer sollten niemals selbst eine Demontage versuchen! Bitte wenden Sie sich an einen Fachmann!"
(EL) : "Προσοχή! Οι χρήστες δεν θα πρέπει ποτέ να προσπαθήσουν να αποσυναρμολογηθούν μόνοι σας!
(HU) : "Figyelmeztetés: a felhasználóknak soha ne próbálják szétbontani a szoftvert!"
(IS) : "Attention! Notendur ættu aldrei að reyna að taka í sundur á eigin spýtur! Vinsamlegast hafðu samband við fagmann!"
(GA) : "Tabhair aire! Níor chóir go n-éireodh le húsáideoirí iad féin a dhíspreagadh dá gcuid féin! Déan teagmháil le gairmí!"
(IT) : "Attenzione: gli utenti non dovrebbero mai tentare di smontare da soli! Si prega di contattare un professionista!"
(LV) : "Uzmanību! Lietotāji nekad nevajadzētu mēģināt izjaukt paši! Lūdzu, sazinieties ar profesionālu!"
(LT) : "Dėmesio! Vartotojai niekada neturėtų bandyti išardyti savęs! Prašau susisiekti su profesionalu!"
(MK) : "Внимание! Корисниците никогаш не треба да се обидуваат сами да ги размонтираат! Ве молиме контактирајте со професионалец!"
(MT) : "Attenzjoni! L-utenti qatt ma għandhom jippruvaw jiżżarmaw waħedhom! Jekk jogħġbok ikkuntattja professjonist!"
(NO) : "Oppmerksomhet! Brukere bør aldri forsøke demontering på egen hånd! Ta kontakt med en profesjonell!"
(PL) : "Uwaga! Użytkownicy nigdy nie powinni próbować samodzielnego demontażu! Skontaktuj się z profesjonalistą!"
(PT) : "Atenção! Os usuários nunca devem tentar a desmontagem por conta própria! Entre em contato com um profissional!"
(RO) : "Atenție: utilizatorii nu ar trebui să încerce niciodată dezamblarea pe cont propriu!
(SR) : "Пажња! Корисници никада не би требали покушавати демонтажу! Молимо контактирајте професионалца!"
(SK) : "Pozor! Uživatelia by sa nikdy nemali pokúšať demontáž samy o sebe!
(SL) : "Pozor! Uporabniki nikoli ne smejo poskusiti sami razstavljati!"
(ES) : "¡Atención! ¡Los usuarios nunca deben intentar el desmontaje por sí mismos! ¡Póngase en contacto con un profesional!"
(SV) : "OBS! Användare ska aldrig försöka demontera på egen hand! Vänligen kontakta en professionell!"

⚠ WARNING

Do not touch any electric part with wet hands. you should be power off before touching electric part.

- There is risk of electric shock or fire.

Do not touch refrigerant pipe and water pipe or any internal parts while the unit is operating or immediately after operation.

- There is risk of burns or frostbite, personal injury.

If you touch the pipe or internal parts, you should be wear protection or wait time to return to normal temperature.

- Otherwise, it may cause burns or frostbite, personal injury.

(SQ)

⚠ PARALAJMËRIM

Mos prekni asnjë pjesë elektrike me duar të lagura. Duhet ta fikni energjinë para se të prekni pjesët elektrike.

- Ekziston rreziku i goditjeve elektrike ose zjarrit.

Mos e prekni tubin e antipiretikut dhe tubin e ujit apo asnjë pjesë të brendshme ndërkohë që njësisia është në punë ose menjëherë pas punimit.

- Ekziston rreziku i djegieve, kafshimit nga ngrica ose lëndimeve personale.

Nëse prekni tubin ose pjesët e brendshme, duhet të vishni mjete mbrojtëse ose të prisni që të kthehet në temperaturën normale.

- Përndryshe mund të shkaktojë djegie, kafshime nga ngrica ose lëndime personale.

(BS)

⚠ UPOZORENJE

Ne dodirujte ni jedan električni dio vlažnim rukama. trebalo bi da isključite napajanje prije dodirivanja električnih dijelova.

- Postoji rizik od strujnog udara ili požara.

Ne dodirujte rashladnu cijev i vodovodnu cijev ili bilo koji drugi unutarnji dio tokom ili odmah poslije rada.

- Postoji opasnost od opekotina ili promrzlina, tjelesne povrede.

Ako dodirnete cijev ili unutarnje dijelove, trebalo bi da nosite zaštitu ili da čekate da se vrati na normalnu temperaturu.

- U suprotnom, to može da izazove opekotine ili promrzline, tjelesne povrede.

(BG)

⚠ ПРЕДУПРЕЖДЕНИЕ

Не докосвайте с мокри ръце никоя електрическа част. Изключете захранването, преди да докосвате електрическата част.

- Съществува риск от електрически удар или пожар.

Не докосвайте тръбата за хладилния агент и тръбата за вода, нито която и да е вътрешна част на уреда, докато той работи или току-що е спръл.

- Съществува риск от изгаряне, измръзване и наранявания.

Ако е необходимо да докосвате тръби или вътрешни части, трябва да носите предпазни ръкавици или да изчакате, докато тръбите или частите достигнат нормална температура.

- В противен случай съществува риск от изгаряне, измръзване и наранявания.

(HR)

⚠ UPOZORENJE

Nijedan električni dio ne dodirujte vlažnim rukama. Prije dodirivanja električnih dijelova isključite napajanje.

- Postoji opasnost od električnog udara ili požara.

Ne dodirujte cijev rashladnog sredstva i cijev za vodu ili bilo koje unutarnje dijelove dok uređaj radi ili neposredno nakon što je prestao s radom.

- Postoji opasnost od opekline, ozeblina ili tjelesnih ozljeda.

Ako dodirujete cijev ili unutarnje dijelove, nosite zaštitne rukavice ili pričekajte da se temperatura vrati u normalu.

- U suprotnom, može uzrokovati opekline, ozeblina ili tjelesne ozljede.

<p>(CS) VAROVÁNÍ</p> <p>Žádné elektrické součásti se nedotýkejte vlhkýma či mokřýma rukama. Než se dotknete elektrické součásti, je třeba odpojit napájení.</p> <p>Když je jednotka v provozu nebo těsně po skončení provozu, nedotýkejte se chladicího ani vodního potrubí ani žádných vnitřních součástí.</p> <p>Při dotyku potrubí či interních součástí je třeba nosit ochranné pomůcky nebo vyčkat, až se obnoví jejich běžná teplota.</p> <ul style="list-style-type: none"> Hrozí nebezpečí úrazu elektrickým proudem či požáru. Hrozí nebezpečí popálenin či omrzlin a zranění osob. Jinak hrozí nebezpečí popálenin či omrzlin a zranění osob. 	<p>(DA) ADVARSEL</p> <p>Rør ikke ved nogen elektriske dele med våde hænder. Der skal være slukket for strømmen til anlægget, før du berører de elektriske dele.</p> <p>Rør ikke køle- og vandrør eller andre interne dele, mens anlægget er i drift eller umiddelbart efter anvendelse.</p> <p>Hvis der røres ved rør eller indvendige dele, skal der anvendes beskyttelsesudstyr eller der ventes til anlægget er kølet af.</p> <ul style="list-style-type: none"> Der kan opstå fare for elektrisk stød eller brand. Der kan opstå fare for brandskader eller forfrysninger og tilskadekomst. Der kan opstå fare for forbrændinger, forfrysninger eller personskade.
<p>(NL) WAARSCHUWING</p> <p>Raak geen elektrische onderdelen aan met natte handen. U moet de stroom eraf halen voordat u elektrische onderdelen aanraakt.</p> <p>Raak de koelmiddelleiding en waterleiding of interne onderdelen niet aan wanneer de unit in werking is of direct na werking.</p> <p>Als u de leiding of interne onderdelen aanraakt, moet u bescherming dragen of een tijdje wachten tot de temperatuur weer normaal is.</p> <ul style="list-style-type: none"> Er bestaat risico op een elektrische schok of brand. Er bestaat risico op brandwonden of bevriezing, lichamelijk letsel. Anders kan dít brandwonden of bevriezing veroorzaken, lichamelijk letsel. 	<p>(ET) HOIATUS</p> <p>Ärge puudutage elektriosasid märgade kätega, enne elektriosade puudutamist lülitage toide välja.</p> <p>Ärge puudutage seadme töötamise ajal või vahetult pealt selle töötamist külmutusagensi toru, veetoru ega ühtegi seadme sise-mist osa.</p> <p>Torude või sisemiste osade puudutamisel tuleb teil kanda kaitsevarustust või peate ootama, kuni seadme temperatuur normaliseerub.</p> <ul style="list-style-type: none"> Elektriilöögi- või tuleoht. Põletuse, külmakahjustuse või kehavigastuse oht. Vastasel juhul on põletuse, külmakahjustuse või kehavigastuse oht.
<p>(FI) VAROITUS</p> <p>Älä koske sähköisiin osiin märin käsin. Virta on kytkettävä pois päältä ennen sähköisiin koskemista.</p> <p>Älä koske kylmäainejohtoon ja vesijohtoon tai sisäosiin, kun laite on toiminnassa tai välittömästi sen päätyttyä.</p> <p>Jos kosketat johtoa tai sisäisiä osia, sinun pitäisi käyttää suojakäsineitä tai odottaa kunnes laite saavuttaa normaalin lämpötilan.</p> <ul style="list-style-type: none"> Ohjeen noudattamatta jättäminen voi aiheuttaa tulipalon ja sähköiskun. Tämä voi johtaa paleltumis- tai henkilövammaan. Muussa tapauksessa on palovammojen tai paleltumien ja henkilövahingon vaara. 	<p>(FR) AVERTISSEMENT</p> <p>Ne touchez aucune pièce électrique avec les mains humides. Coupez l'alimentation électrique avant de toucher les pièces électriques.</p> <p>Ne touchez pas le tuyau de réfrigérant ni la conduite d'eau ou toute pièce interne pendant le fonctionnement de l'unité ou immédiatement après.</p> <p>Si vous voulez toucher le tuyau ou des pièces internes, portez une protection ou attendez le retour à la température normale.</p> <ul style="list-style-type: none"> Il existe un risque de décharge électrique ou d'incendie. Il existe un risque de brûlures, d'engelures ou d'autres blessures. À défaut, vous risquez des brûlures, des engelures ou d'autres blessures.
<p>(DE) ACHTUNG</p> <p>Elektrische Bauteile niemals mit feuchten oder nassen Händen berühren. Vor dem Berühren elektrischer Bauteile sollte die Stromversorgung unterbrochen werden.</p> <p>Kältemittel- und Wasserrohre oder sonstige interne Bauteile während des Betriebs oder unmittelbar nach dem Betrieb nicht berühren.</p> <p>Rohrleitungen oder interne Bauteile sollten nur mit entsprechender Schutzkleidung oder nach dem Abkühlen der Bauteile berührt werden.</p> <ul style="list-style-type: none"> Es besteht Stromschlag- oder Brandgefahr. Es besteht die Gefahr von Verbrennungen, Erfrierungen oder Verletzungen. Ansonsten besteht die Gefahr von Verbrennungen, Erfrierungen oder Verletzungen. 	<p>(EL) ΠΡΟΕΙΔΟΠΟΙΗΣΗ</p> <p>Μην ακουμπάτε οποιοδήποτε ηλεκτρικό εξάρτημα με βρεγμένα χέρια. Απενεργοποιήστε την ισχύ προτού ακουμπήσετε ηλεκτρικά μέρη.</p> <p>Μην ακουμπάτε τον σωλήνα του ψυκτικού ή τα εσωτερικά μέρη ενώ λειτουργεί η μονάδα ή αμέσως μετά τη λειτουργία.</p> <p>Εάν ακουμπήσετε τον σωλήνα ή τα εσωτερικά μέρη, πρέπει να φοράτε προστατευτικά ή να περιμένετε για κάποια ώρα ώστε να επιστρέψει η κανονική θερμοκρασία.</p> <ul style="list-style-type: none"> Υπάρχει κίνδυνος εγκαυμάτων, κρουσπαγήματος ή τραυματισμού. Αλλιώς, πιθανόν να προκληθούν εγκαυματα, κρουσπαγήματα ή τραυματισμός.
<p>(HU) FIGYELEM</p> <p>Nedves kézzel ne érintse meg az elektromos alkatrészeket. Az elektromos alkatrészek megérintése előtt kapcsolja ki a hálózati feszültséget.</p> <p>Működés közben, illetve közvetlenül a leállítás után ne érintse meg a hűtőcsövet, vízcövet, vagy bármelyik belső alkatrészt.</p> <p>A csöveket vagy belső alkatrészeket csak védőkesztyűvel, vagy a készülék szobahőmérsékletre hűlése után érintse meg.</p> <ul style="list-style-type: none"> Fennáll az áramütés vagy a tűz veszélye. Fennáll az égés, lagyási sérülés és személyi sérülés veszélye. Egyébként fennáll az égés, lagyási sérülés és személyi sérülés veszélye. 	<p>(IS) VIÐVÖRUN</p> <p>EKKI koma við neina rafmagnshluta með blautum höndum. Þú ættir að slökka á aflí áður en komið er við rafmagnshluta.</p> <p>EKKI koma við kælfirnaleiðslur, vatnsleiðslur eða einhverja innri hluti á meðan eining starfar eða strax eftir starfsemi.</p> <p>Ef þú kemur við leiðslu eða innri hluti ættirðu að vera með hlífara eða bíða þangað til einingin er komin niður í eðlilegt hitastig.</p> <ul style="list-style-type: none"> Það er hættu á raflosti eða eldsvoða. Það er hættu á bruna eða kali eða persónulegum meiðslum. Annars gæti það valdið bruna, kali eða persónulegum meiðslum.
<p>(GA) RABHADH</p> <p>Á dteagmháil aon chuid leictreach leis na lámha fliuch. Á chóir duit a bheith de chumhacht amach roimh touching chuid leictreacha.</p> <p>Á dteagmháil piopa cuisneán agus piopa uisce nó aon chodanna inmheánach, ba cheart duit a bheith a chaitheamh le coisaint nó fanacht am chun fillleadh ar an teocht an gnáth.</p> <p>Á tús teagmháil an piopa nó codanna inmheánach, ba cheart duit a bheith a chaitheamh le coisaint nó fanacht am chun fillleadh ar an teocht an gnáth.</p> <ul style="list-style-type: none"> Á baol turraing leictreach nó tine. Á baol dó nó reo frithe, diobháil phearsanta. Eachas sin, d'fhéadfadh sé ina chúis le dóna nó , diobháil phearsanta. 	<p>(IT) AVVERTENZA</p> <p>Non toccare le parti elettriche con le mani bagnate. Prima di toccare parti elettriche spegnere l'unità.</p> <p>Non toccare il tubo del refrigerante e il tubo dell'acqua o le parti interne mentre l'unità è in funzione o subito dopo il funzionamento.</p> <p>Se si tocca il tubo o le parti interne, si dovrebbe indossare una protezione o attendere che l'unità a temperatura normale.</p> <ul style="list-style-type: none"> Vi è il rischio di scossa elettrica o incendio. Vi è il rischio di lesioni personali, ustioni o congelamento. In caso contrario , ciò potrebbe provocare lesioni personali, ustioni o congelamenti.
<p>(LV) BRĪDINĀJUMS</p> <p>Nepieskarieties elektriskajām daļām ar mitrām rokām. Pirms pieskaraties elektriskai daļai, atslēdziet strāvu.</p> <p>Nepieskarieties aukstumāgēnta caurulei un ūdens caurulei vai iekšējām daļām, kamēr ierīces darbojas vai uzreiz pēc tās darbības.</p> <p>Pieskaroties caurulei vai iekšējām daļām, jālieto aizsargtērps vai jānogaida, līdz ierīces temperatūras atgriežas normas robežās.</p> <ul style="list-style-type: none"> Pastāv elektriskās strāvas trieciena vai ugunsgrēka risks. Pastāv apdegumu, apsaldējumu vai traumu risks. Pretejā gadījumā pastāv apdegumu, apsaldējumu vai traumu risks. 	<p>(LT) ĮSPĖJIMAS</p> <p>Nelieskite elektroninių dalių šlapiomis rankomis. Išjunkite įrenginį prieš lieddami elektronines dalis.</p> <p>Nelieskite šaldalo bei vandens vamzdžių ar vidinių dalių kol įrenginys atlieka darbą ar tuojau pat po darbo atlikimo.</p> <p>Jeigu liestis prie vamzdžių ar vidinių dalių, pasirūpinkite apsauga arba palaukite kurį laiką, kol temperatūra bus normali.</p> <ul style="list-style-type: none"> Kyla elektros šoko arba gaisro pavojus. Galite nušalti ar susižaloti. Kitaip galite nušalti ar susižaloti.
<p>(MK) ПРЕДУПРЕДУВАЊЕ</p> <p>Да не ги фаќате електричните делови со мокри раце. Треба прво да ја исклучите струјата пред да ги допирате електричните делови.</p> <p>Да не ја допирате цевката за средство за ладење или внатрешни делови додека работи единицата или веднаш по работењето.</p> <p>Ако ја допрете цевката или внатрешни делови, треба да носите заштитна опрема или да почекате да се се врати на нормална температура.</p> <ul style="list-style-type: none"> Постои опасност од струен удар или пожар. Постои опасност од изгореници или замрзнатини, телесна повреда. Инаку, може да предизвика изгореници или замрзнатини и телесна повреда. 	<p>(MT) TWISSIJA</p> <p>Tmiss l-ebda parti elettrika b'idejn imxarriba. Trid tkun tfejt l-eletriku qabel tmiss il-parti elettrika.</p> <p>Tmissx il-pajp tar-refrigerant u l-pajp tal-ilma jew kwalunkwe parti fuq ġewwa waqt li t-tagħmir ikun mixgħul jew immedjatament wara li titfih.</p> <p>Jekk tmiss il-pajp jew partijiet ta' ġewwa, jehtieg li tilbes ilbies protettiv jew tistenna sakem il-temperatura tiġi lura għan-normal.</p> <ul style="list-style-type: none"> Hemm riskju ta' xokk elettriku jew nieren. Hemm riskju ta' hruq jew infjammazzjoni bil-ksieh, korriment personali. Inkella, dan jista' jikkawza hruq jew infjammazzjoni bil-ksieh, korriment personali.
<p>(NO) ADVARSEL</p> <p>De elektriske delene må ikke berøres med våte hender, strømtilførselen må slås av før berøring. Strømmen skal slås av for du rører elektriske deler.</p> <p>Kjølerøret og vannrøret eller andre indre deler må ikke berøres mens enheten er i gang eller umiddelbart etter bruk.</p> <p>Hvis du må ta på røret eller andre indre deler, bruk verneutstyr eller vent til temperaturen har gått ned.</p> <ul style="list-style-type: none"> Det er fare for elektrisk stød eller brann. Det er risiko for brannskade eller frostbitt, personskade. Hvis ikke kan det forårsake brannskader eller frostskaider, og personlige skader. 	<p>(PL) OSTRZEŻENIE</p> <p>Nie dotykac żadnej części elektrycznej mokrymi rękami. Przed dotknięciem części elektrycznej należy odciąć zasilanie.</p> <p>Nie wolno dotykać rury z czynnikiem chłodzącym, rury z wodą oraz żadnej części wewnętrznej podczas gdy urządzenie pracuje lub zaraz po jego wyłączeniu.</p> <p>Jeżeli musisz dotknąć rurę lub elementy wewnętrzne, należy uprać ubranie ochronne lub odczekać, aż osiągną odpowiednią temperaturę.</p> <ul style="list-style-type: none"> Występuje ryzyko porażenia elektrycznego lub pożaru. Występuje ryzyko oparzenia odmrożenia lub zranienia. W przeciwnym razie może dojść do oparzenia odmrożenia lub zranienia.

<p>(PT) AVISO</p> <p>Não toque em nenhuma peça eléctrica com as mãos molhadas. Deve desligar a alimentação antes de tocar na parte eléctrica.</p> <p>Não toque no tubo de refrigerante e na tubagem de água ou em quaisquer peças internas, enquanto a unidade estiver em funcionamento ou imediatamente após o funcionamento.</p> <p>Se tocar no tubo ou nas peças internas, deve usar óculos de protecção ou esperar o tempo suficiente para voltar à temperatura normal.</p> <ul style="list-style-type: none"> Há o risco de incêndio ou de choque eléctrico. Existe o risco de queimaduras ou congelação, ferimentos pessoais. Caso contrário, pode provocar queimaduras ou congelação, ferimentos pessoais. 	<p>(RO) AVERTISMENT</p> <p>Nu atingeți nicio componentă electrică cu mâinile ude. Trebuie să opriți alimentarea electrică înainte de atingerea componentei electrice.</p> <p>Nu atingeți țeava pentru agentul termic și țeava de apă sau vreo componentă internă în timp ce unitatea funcționează sau imediat după funcționare.</p> <p>Dacă atingeți țeava sau componentele interne, trebuie să purtați protecție sau să așteptați revenirea la temperatura normală.</p> <ul style="list-style-type: none"> Există riscul de electroșoc sau incendiu. Există riscul de arsuri sau degerătură, sau de vătămare corporală. În caz contrar, acest lucru poate cauza arsuri sau degerătură, sau vătămare personală.
<p>(SR) UPOZORENJE</p> <p>Ne dodirujte električne delove vlažnim rukama. Trebalo bi da isključite napajanje pre nego što imate dodir sa električnim delovima.</p> <p>Ne dodirujte cev za rashladno sredstvo i cev za vodu ili unutrašnje delove dok uređaj radi ili neposredno nakon prekida rada.</p> <p>Ako dodirujete cev ili unutrašnje delove, trebalo bi da nosite zaštitnu opremu ili da sačekate neko vreme dok se temperatura ne vrati na normalu.</p> <ul style="list-style-type: none"> Postoji rizik od strujnog udara ili požara. Postoji opasnost od opekotina ili promrzlina, telesnih ozleđa. U suprotnom postoji opasnost od opekotina ili promrzlina, odnosno telesnih ozleđa. 	<p>(SK) UPOZORNENIE</p> <p>Nedotýkajte sa žiadnej elektrickej časti mokrými rukami. Pred dotykom elektrickej časti vypnite napájanie.</p> <p>Nedotýkajte sa potrubia s chladivom a potrubia s vodou, ani žiadnej inej vnútornej časti, pokiaľ je jednotka v prevádzke alebo bezprostredne po jej vypnutí.</p> <p>Ak sa potrebujete dotknúť potrubia alebo inej vnútornej časti, mali by ste mať ochranný odev alebo počkať, kým sa jednotka nevráti na normálnu teplotu.</p> <ul style="list-style-type: none"> Hrozí riziko zásahu elektrickým prúdom a požiaru. Hrozí riziko popálenín alebo omrzlín, zranenia osôb. V opačnom prípade môže dôjsť k popáleninám alebo omrzlinám, zraneniu osôb.
<p>(SL) OPOZORILO</p> <p>Ne dotikajte se električnih delov z mokrimi rokami. pred dotikanjem električnih delov morate izklopiti napajanje.</p> <p>Ne dotikajte se cevi za hladilno tekočino in cevi za vodo ali katerikoli notranjih delov medtem, ko enota deluje, ali takoj po delovanju.</p> <p>Če se dotikate cevi ali notranjih delov, morate nositi zaščito ali počakati, da se enota povrne v normalno temperaturo.</p> <ul style="list-style-type: none"> Obstaja nevarnost udara električnega toka ali požara. Obstaja možnost opeklin, ozeblin in telesne poškodbe. Sicer obstaja možnost opeklin, ozeblin in telesne poškodbe. 	<p>(ES) ADVERTENCIA</p> <p>No toque ninguna parte eléctrica con las manos mojadas. Desconecte la alimentación eléctrica antes de tocar las partes eléctricas.</p> <p>No toque el tubo de refrigerante y el tubo del agua o cualquier parte interna con la unidad en funcionamiento o inmediatamente después de su parada.</p> <p>Si toca el tubo o las partes internas, deberá utilizar protección o esperar a que hayan recuperado la temperatura normal.</p> <ul style="list-style-type: none"> Existe riesgo de descarga eléctrica o incendio. Existe riesgo de lesiones, quemaduras o congelación. De lo contrario, podría sufrir quemaduras, congelaciones o lesiones.
<p>(SV) VARNING</p> <p>Vidrör inga elektriska delar med fuktiga händer. Se till att strömmen är avstängd innan du vidrör elektriska delar.</p> <p>Vidrör ej kylmedels- eller vattenrör eller några interna delar när enheten är i drift eller omedelbart därefter.</p> <p>Om du vidrör rör eller interna delar bör du bära skyddsutrustning eller vänta tills enheten återgått till normal temperatur.</p> <ul style="list-style-type: none"> Risk för elstöt eller brand föreligger. Risk för bränn-, köld- och personskador föreligger. I annat fall föreligger risk för bränn-/frostskador eller personskador. 	

DISASSEMBLY GUIDE (1/2)

“Attention! Users should never attempt disassembly on their own! Please contact a professional!”

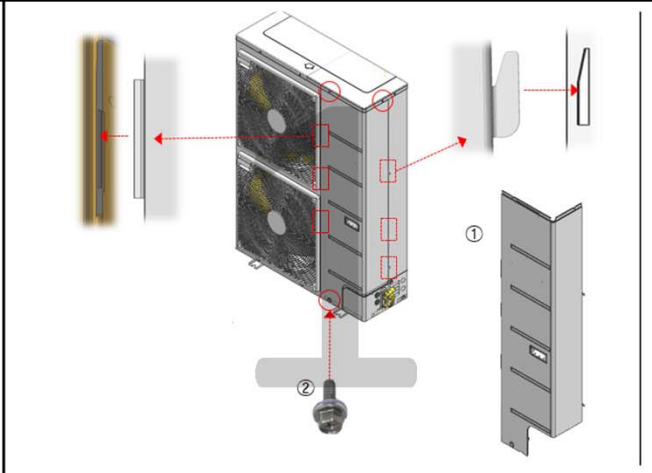
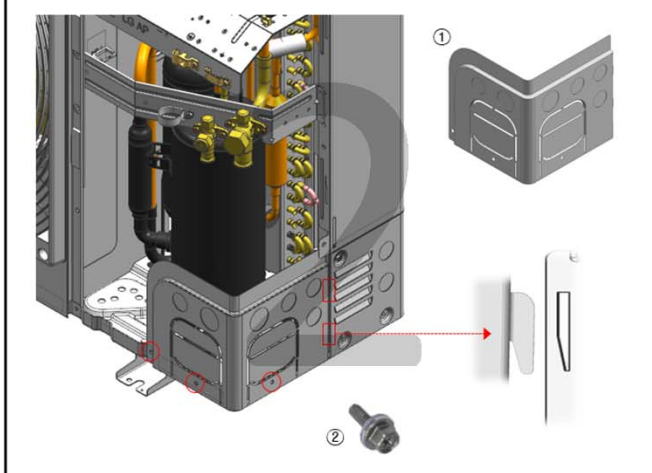
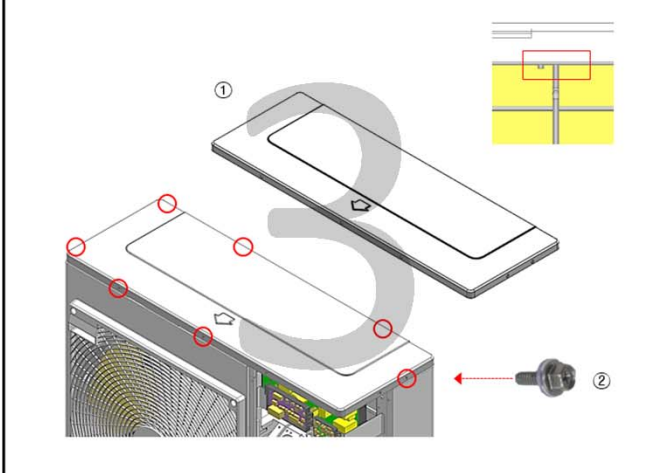
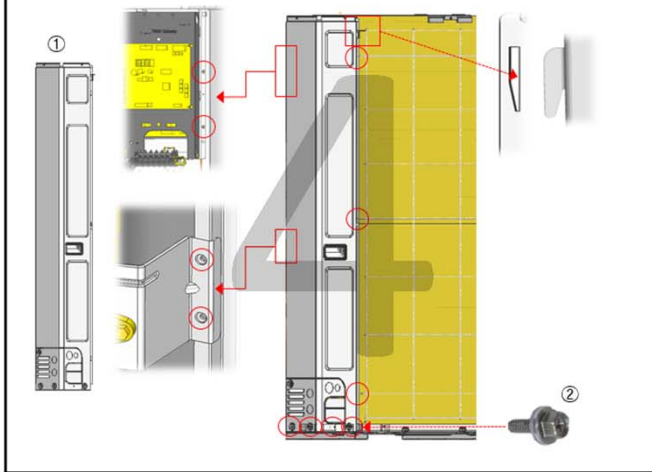
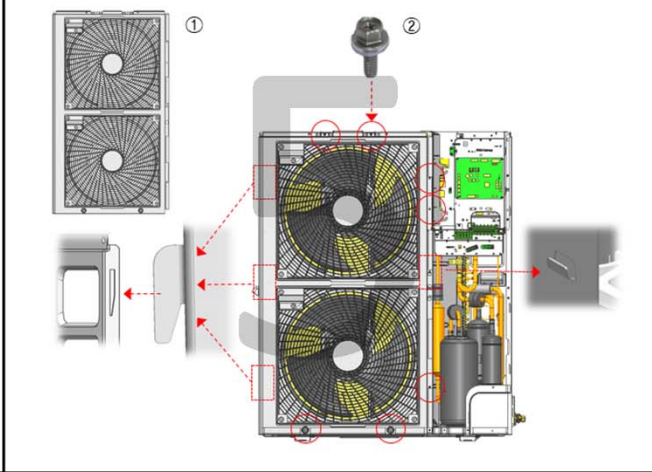
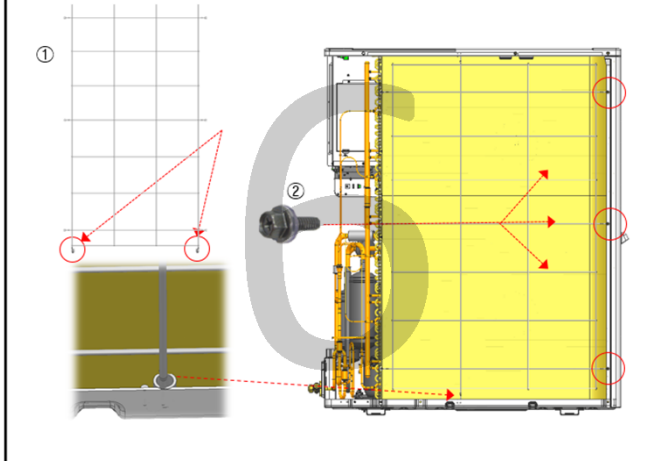
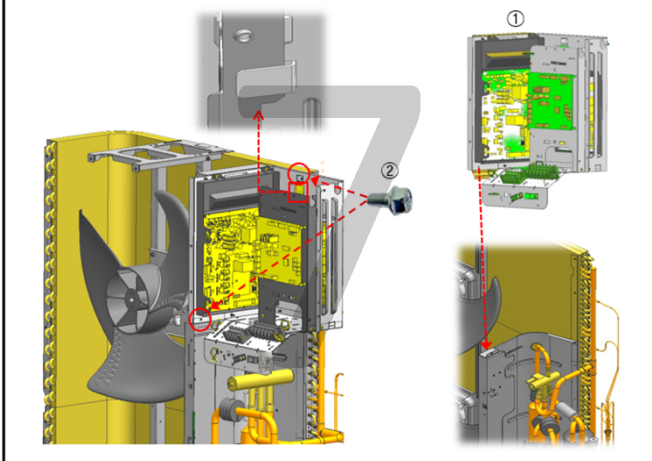
<div style="border: 1px solid black; padding: 5px; text-align: center; margin-bottom: 10px;"> ⚠ WARNING </div> <p>Do not touch any electric part with wet hands. you should be power off before touching electric part.</p> <ul style="list-style-type: none"> • There is risk of electric shock or fire. <p>Do not touch refrigerant pipe and water pipe or any internal parts immediately after turn off the unit.</p> <ul style="list-style-type: none"> • There is risk of burns or frostbite, personal injury. <p>If you touch the pipe or internal parts, you should be wear protection or wait time to return to normal temperature.</p> <ul style="list-style-type: none"> • Otherwise , it may cause burns or frostbite, personal injury. 	
	
	
	

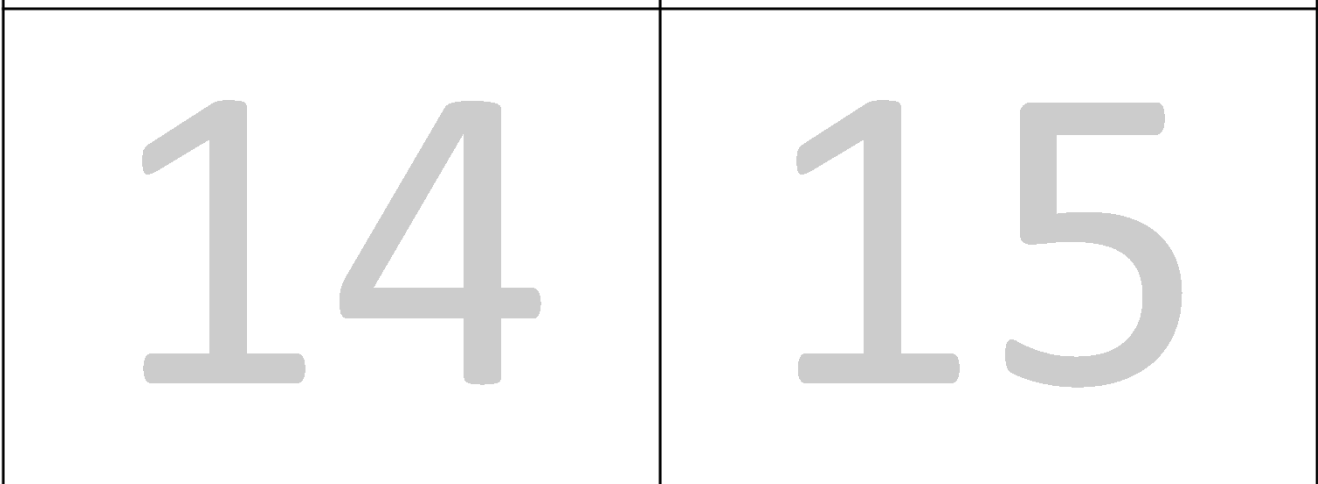
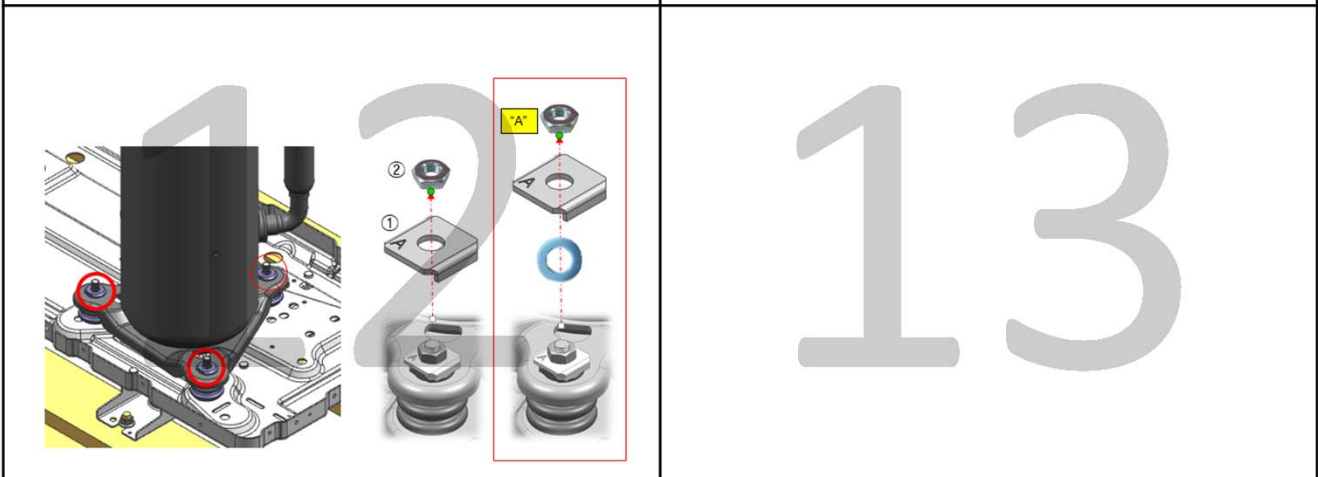
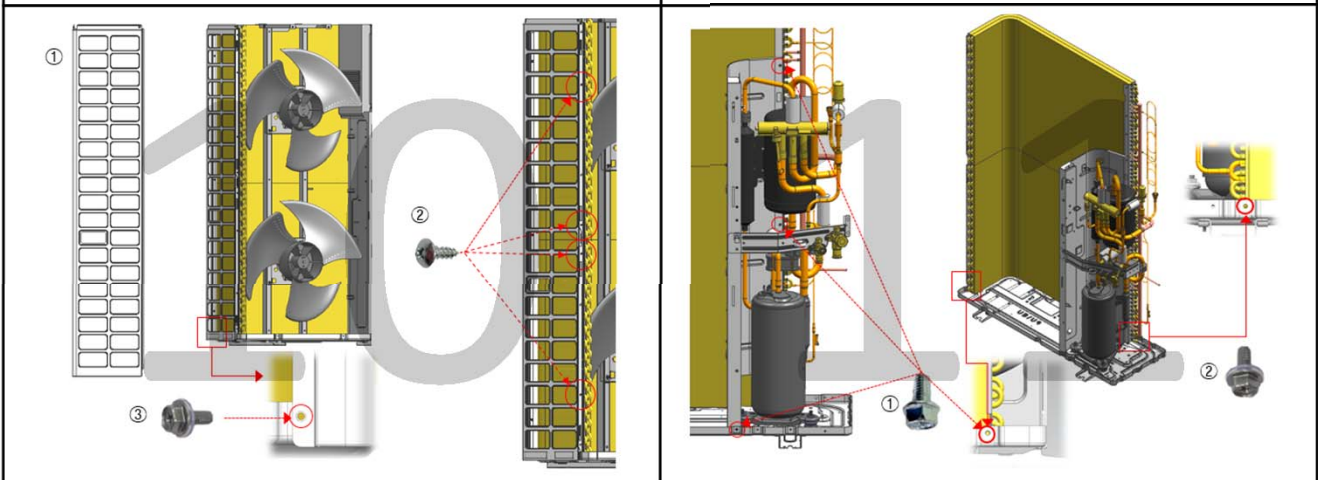
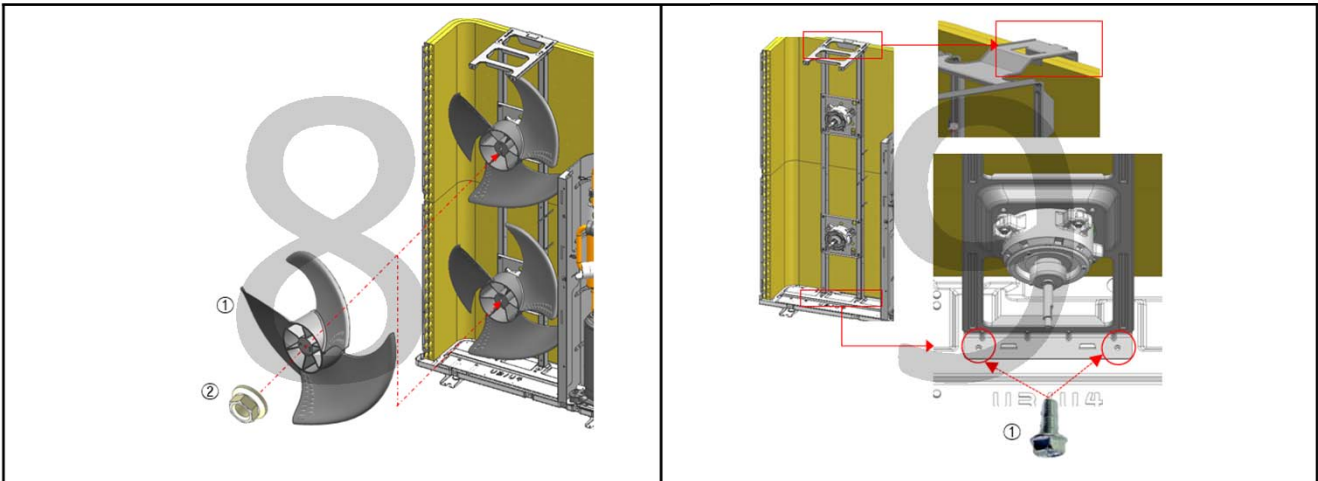

DISASSEMBLY GUIDE (2/2)

"Attention! Users should never attempt disassembly on their own! Please contact a professional!"

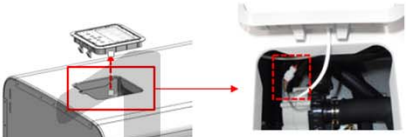
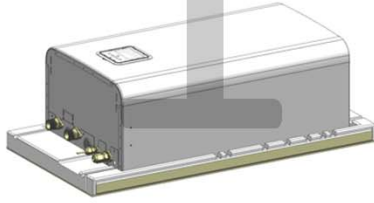

DISASSEMBLY GUIDE (1/2)

“Attention! Users should never attempt disassembly on their own! Please contact a professional!”

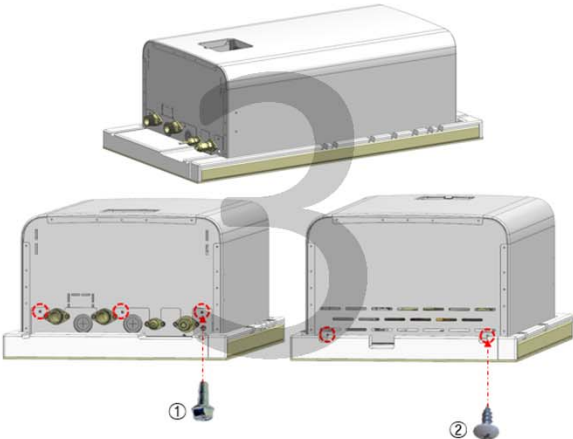
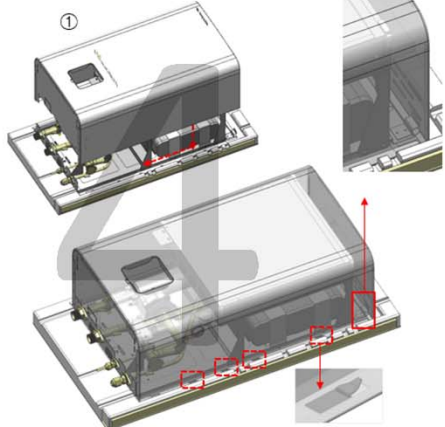
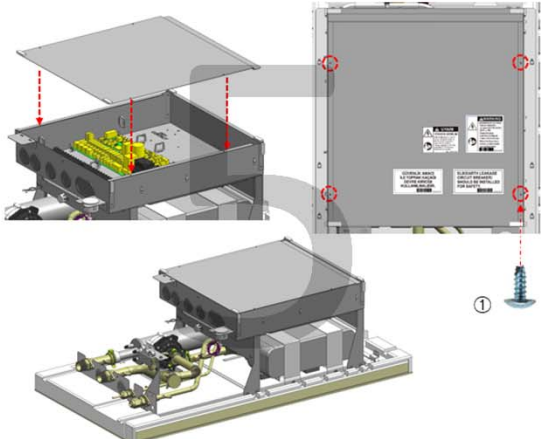
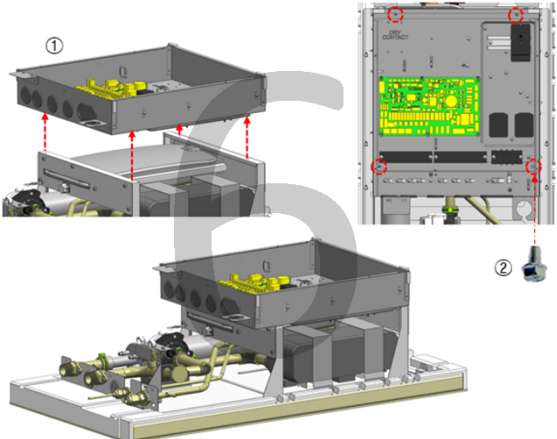
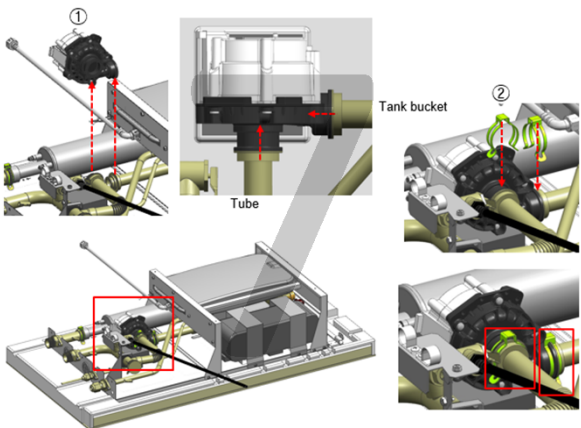
<div style="border: 1px solid black; padding: 5px; margin-bottom: 10px; text-align: center;"> ⚠ WARNING </div> <p>Do not touch any electric part with wet hands. you should be power off before touching electric part.</p> <ul style="list-style-type: none"> • There is risk of electric shock or fire. <p>Do not touch refrigerant pipe and water pipe or any internal parts immediately after turn off the unit.</p> <ul style="list-style-type: none"> • There is risk of burns or frostbite, personal injury. <p>If you touch the pipe or internal parts, you should be wear protection or wait time to return to normal temperature.</p> <ul style="list-style-type: none"> • Otherwise , it may cause burns or frostbite, personal injury. 	 
	
	
	

DISASSEMBLY GUIDE (2/2)

“Attention! Users should never attempt disassembly on their own! Please contact a professional!”

