



DVS-PY SUPPLY AIR VALVE

AIR MANAGEMENT SYSTEMS

PRODUCT PROPERTIES

Stainless steel valve including fixing collar

DVS-PY is a supply valve suitable for houses, offices etc.

- Good adjusting features
- Low noise level
- Quick and easy to install
- Airflow easy to measure

CONSTRUCTION

The **DVS-PØY** is manufactured from Stainless steel alloy AISI304/2B. The valve body has a gasket, made of cellular plastic and the control disc, with screw spindle, enables easy regulation and positional locking. Fixing collar **DVS-FY** is manufactured from Stainless steel alloy AISI304/2B.

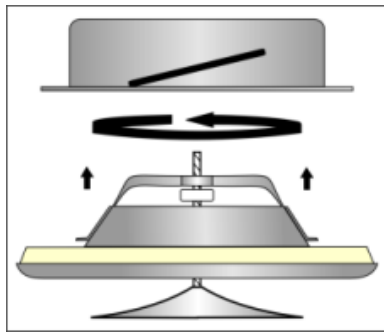

DIMENSIONS in mm

DVS-PY	Ø 080	Ø 100	Ø 125	Ø 160	Ø200
A	116	140	166	209	248
B	80	91	112	148	196
C	40	40	46	54	59
W (gr)	122	165	226	334	520
D	105	125	150	185	225
E	79	99	124	159	199
W (gr)	74	89	112	165	212

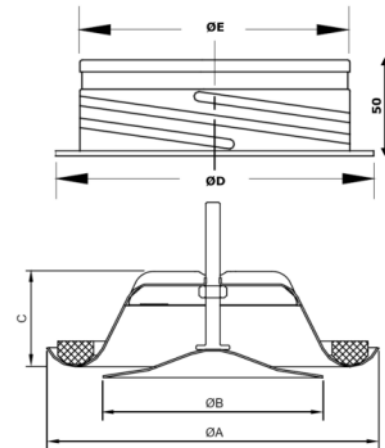

REGULATION AND MEASUREMENTS

Regulation of airflow is achieved by turning the control disc to change adjustment dimension a (mm). The measurement of airflow is made by a pressure difference measurement with a separate measuring tube. Refer to airflow measurement diagrams for information.

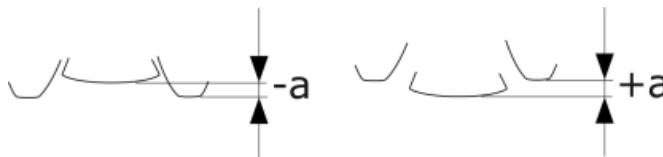

LIABILITY:

The information contained in this brochure was current on the publication date. DEC INTERNATIONAL reserves the right to make changes in details at any time without prior notice. In order to avoid misunderstandings, any interested party is advised to contact DEC INTERNATIONAL checking for any changes in materials and/or information after this brochure was published.

PLEASE NOTICE:

The consultant is responsible for the actual installation and mounting of the product. The mentioned values with respect to temperatures are not appropriate to be used to determine the physical properties. These properties are also dependent on humidity and the temperature of the air inside and outside of the H.V.A.C. system.

TRADEMARKS:

DEC International and the DEC logo are trademarks, or registered trademarks of Dutch Environment Corporation BV in the Netherlands and/or other countries.





DVS-PY SUPPLY AIR VALVE

AIR MANAGEMENT SYSTEMS

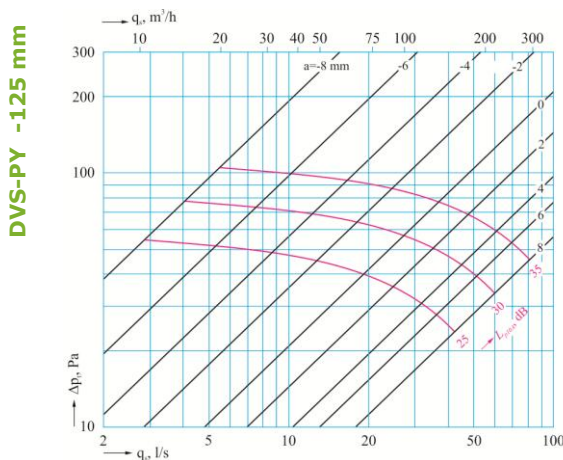
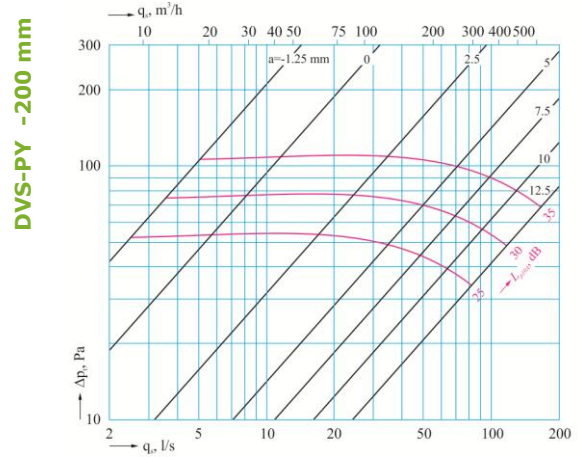
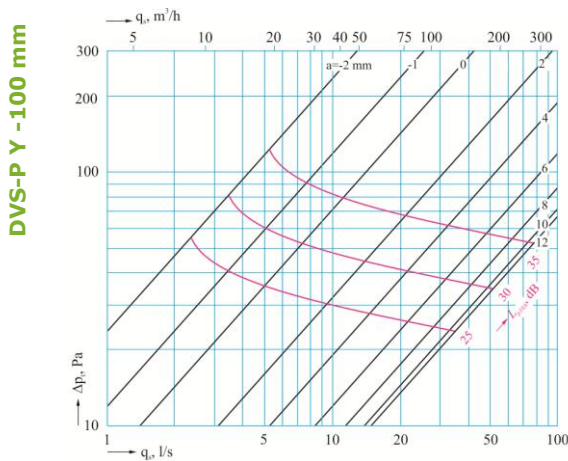
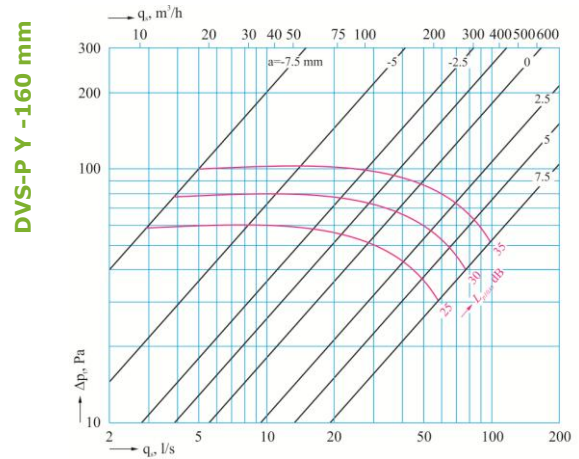
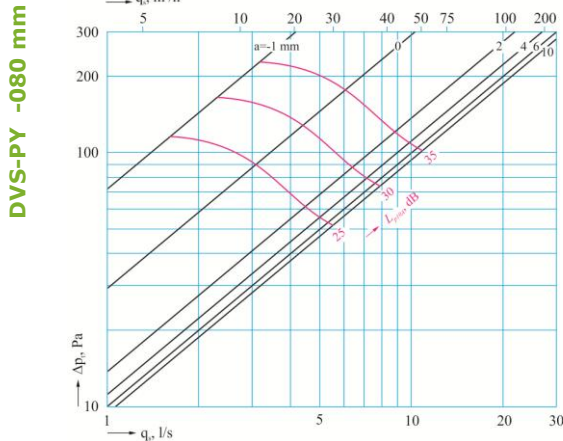

DEFINITIONS

q_v	air volume	(m ³ /h)
Δp_t	total pressure drop	(Pa)
L_{p10A}	sound pressure level with 4 dB room attenuation (10 m ² sab)	[dB(A)]

LIABILITY:
The information contained in this brochure was current on the publication date. DEC INTERNATIONAL reserves the right to make changes in details at any time without prior notice. In order to avoid misunderstandings, any interested party is advised to contact DEC INTERNATIONAL checking for any changes in materials and/or information after this brochure was published.

PLEASE NOTICE:
The consultant is responsible for the actual installation and mounting of the product. The mentioned values with respect to temperatures are not appropriate to be used to determine the physical properties. These properties are also dependent on humidity and the temperature of the air inside and outside of the H.V.A.C. system.

TRADEMARKS:
DEC International and the DEC logo are trademarks, or registered trademarks of Dutch Environment Corporation BV in the Netherlands and/or other countries.

