



INSTALLATION MANUAL

Outdoor unit for air to water heat pump

ERSQ011AAV1
ERSQ014AAV1
ERSQ016AAV1

ERRQ011AAV1
ERRQ014AAV1
ERRQ016AAV1

ERSQ011AAY1
ERSQ014AAY1
ERSQ016AAY1

ERRQ011AAY1
ERRQ014AAY1
ERRQ016AAY1

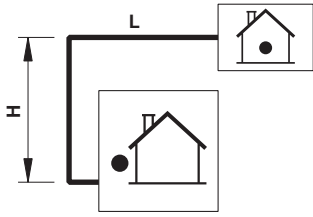

1

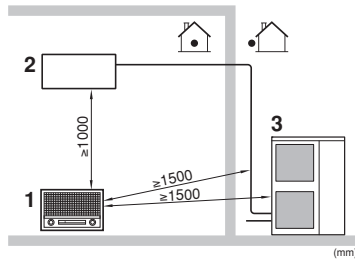

2

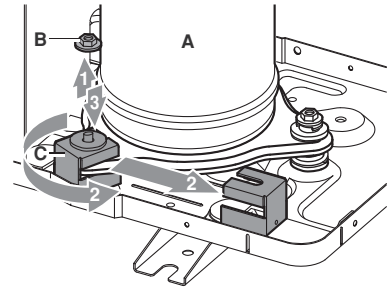

3

	↙	↘	↖	↗		A	B1	B2	C	D1	D2	E	L1/L2		
	✓						≥100								
	✓		✓	✓		≥100	≥100		≥100						
	✓				✓		≥100			≤500	≥1000				
	✓		✓	✓	✓	≥150	≥150		≥150	≤500	≥1000				
		✓								≥500					
		✓								≤500	≥500	≥1000			
	✓	✓				L2>H	≥100			≥500				3	
						L2<H	≥100			≥500					
						L2>H	L1≤H	≥250	≤500	≥750	≥1000	≥1000	0<L2≤1/2 H	1/2 H<L1≤H	1
		✓	✓		✓	H<L1	L1≤H								
	✓					≥200	≥300		≥1000						
	✓		✓	✓	✓	≥200	≥300		≥1000		≤500	≥1000			
		✓								≥1000					
		✓			✓				≤500	≥1000		≥1000			
	✓	✓				L2>H	≥300			≥1000				3	
						L2<H	≥250			≥1500			0<L2≤1/2 H	1/2 H<L2≤H	3
						L2>H	L1≤H	≥300	≤500	≥1000	≥1000	0<L1≤1/2 H	1/2 H<L1≤H	1+2	
		✓	✓		✓	H<L1	L1≤H								
						L2<H	L2≤H	≥250		≥1500	≤500	≥1000	0<L2≤1/2 H	1/2 H<L2≤H	3
						H<L2	L2≤H								

4

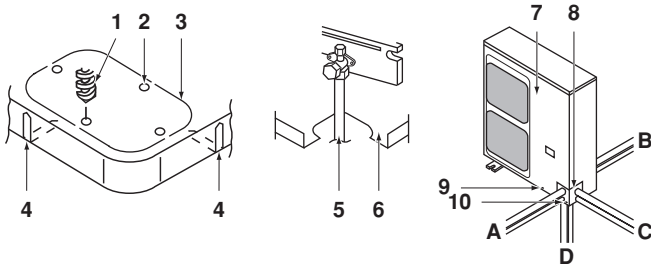

5

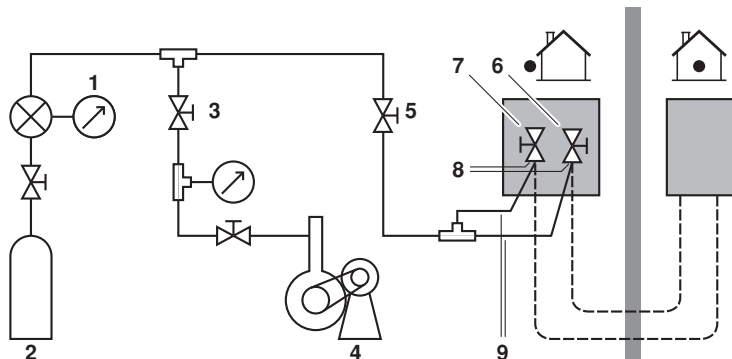

6

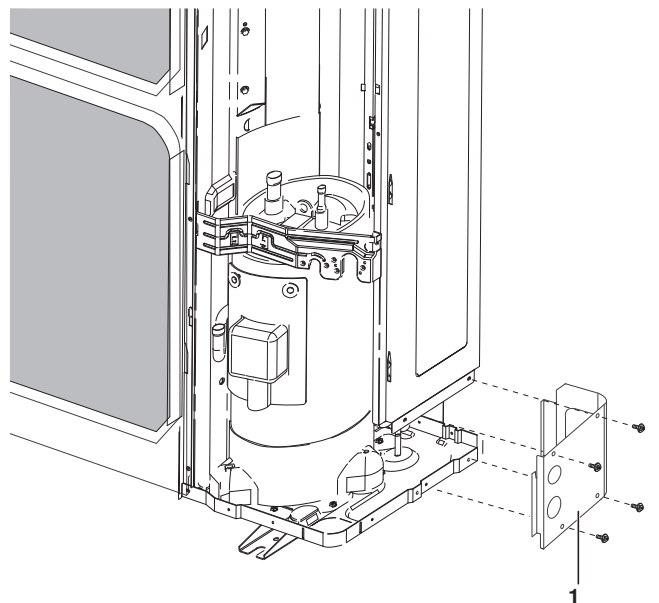

7

CE - DECLARATION-OF-CONFORMITY
CE - KONFORMITÄTSPERKLÄRUNG
CE - DECLARATION-DE-CONFORMITE
CE - CONFORMITEITSVERKLARING

Daikin Europe N.V.

- 01 (GB) declares under its sole responsibility that the equipment to which this declaration relates:
02 (DE) erklärt auf seine alleinige Verantwortung, dass die Ausrüstung für die diese Erklärung bestimmt ist:
03 (F) déclare sous sa seule responsabilité que l'équipement visé par la présente déclaration:
04 (NL) verklaart hierbij op eigen exclusieve verantwoordelijkheid dat de apparatuur waarop deze verklaring betrekking heeft:
05 (E) declara bajo su única responsabilidad que el equipo al que hace referencia la declaración:
06 (I) dichiara sotto la propria responsabilità che gli apparecchi a cui è riferita questa dichiarazione:
07 (GR) δηλώνει με αποκλειστική της ευθύνη ότι ο εξοπλισμός στον οποίο αναφέρεται η παρούσα δήλωση:
08 (P) declara sob sua exclusivă responsabilitate că os echipamentele la care se referă această declarație:

ERSQ011AAV1* ERSQ014AAV1* ERSQ016AAV1* ERSQ017AAV1* ERSQ018AAV1* ERSQ019AAV1*
ERSQ011AAV1* ERSQ014AAV1* ERSQ016AAV1* ERSQ017AAV1* ERSQ018AAV1* ERSQ019AAV1*
* _ , 1 , 2 , 3 , ... , 9

01 are in conformity with the following standard(s) or other normative document(s), provided that these are used in accordance with our instructions:
02 der/den folgenden Norm(en) oder einem anderen Normdokument oder -dokumenten entspricht/entsprechen, unter der Voraussetzung, dass sie gemäß unseren Anweisungen eingesetzt werden:

03 sont conformes à la/aux norme(s) et/ou(s) document(s) normatif(s), pour autant qu'ils soient utilisés conformément à nos instructions:
04 conform de volgend(e) norm(e) n(en) of twee andere andere documenten zijn, op voorwaarde dat ze worden gebruikt overeenkomstig onze instructies:
05 están en conformidad con la(s) siguiente(s) norma(s) u otro(s) documento(s) normativo(s), siempre que sean utilizados de acuerdo con nuestras instrucciones:
06 sono conformi allo/i seguente/i standard(i) o altro/i documento(i) a carattere normativo, a patto che vengano usati in conformità alle nostre istruzioni:
07 estei echiparea cu toți aceluși(e) principiu(e) și/dauă standarde(e) normative(e), undă ținând cont de instrucțiunile noastre și de condițiile de utilizare în conformitate cu instrucțiunile noastre:

EN60335-2-40,

- 01 following the provisions of:
02 gemäß den Vorschriften der:
03 conformément aux stipulations des:
04 overeenkomstig de bepalingen van:
05 siguiendo las disposiciones de:
06 secondo le prescrizioni per:
07 με τη τήρηση των διατάξεων των:
08 de acuerdo con el previsto en:
09 в соответствии с положениями:

- 01 Note * as set out in <A> and judged positively by according to the Certificate <C>.
02 Hímeis * wie in der <A> aufgeführt und von positiv beurteilt gemäß Zertifikat <C>.
03 Remarque * tel que défini dans <A> et évalué positivement par conformément au Certificat <C>.
04 Bemerk * zoals vermeld in <A> en positief beoordeeld door overeenkomstig Certificaat <C>.
05 Nota * como se establece en <A> y es valorado positivamente por de acuerdo con el Certificado <C>.
06 Nota * delimito nel <A> e giudicato positivamente da secondo il Certificato <C>.
07 Значијон * опис, одобреног ото на основу Бетификат <C>.
08 Nota * tal como estabelecido en <A> e com o parecer positivo de de acordo com o Certificado <C>.
09 Примечание * как изложено в <A> и в соответствии с положительным решением согласно Сертификату <C>.
10 Bemerk * som artfirt i <A> og positivt vurderet af henholdt til Certifikat <C>.

CE - DECLARACION-DE-CONFORMIDAD
CE - DICHIARAZIONE-DE-CONFORMITA
CE - ΔΗΛΩΣΗ ΣΥΜΜΟΡΦΩΣΗΣ
CE - FÖRSÄKRAN-OM ÖVERENSSTÄMMELSE

- 09 (NB) заявляет, исключительно под свою ответственность, что оборудование, к которому относится настоящее заявление:
10 (DK) erklærer som eneansvarlig, at udstyret, som er omfattet af denne erklæring:
11 (S) deklarerar i egenskap av huvudsvarig, att utrustningen som berörs av denna deklARATION inrättat att:
12 (N) erklærer et fullstændigt ansvar for at det udstyr som berøres af denne deklARATION, indarbejdet at:
13 (NL) imodtaag yisnomaan omalla vastuullaan, että läänän ilmoitukseen tarkoitettuna laitteet:
14 (CZ) prohlašuje ve své plné odpovědnosti, že zařízení, k němuž se toto prohlášení vztahuje:
15 (HR) izjavljuje pod isključivo vlastitom odgovornošću da oprema na koju se ova izjava odnosi:
16 (H) teljes felelősséggel tudatában kijelentem, hogy a bejelentésnek, melyre e nyilatkozat vonatkozik:

CE - IZJAVA O SKLADNOSTI
CE - VASTAVUŠDEKLARACIJA
CE - VYHLÁŠENIE-ZHODY
CE - UYUMLULUK-BİLDİRİSİ

CE - IZJAVA O SKLADNOSTI
CE - VASTAVUŠDEKLARACIJA
CE - VYHLÁŠENIE-ZHODY
CE - UYUMLULUK-BİLDİRİSİ

CE - IZJAVA O SKLADNOSTI
CE - VASTAVUŠDEKLARACIJA
CE - VYHLÁŠENIE-ZHODY
CE - UYUMLULUK-BİLDİRİSİ

- 17 (EL) deklariuje na vlastnu odgovornost, da uređajna, kojoj se deklaracija odnosi:
18 (DE) erklärt je proprio răspundere că echipamentele la care se referă această declarație:
19 (ES) z svo odgovornosti izjavlja, da je oprema naprav, na katero se izjava nanaša:
20 (FR) kinnitab oma täieliku vastutuse, et käesoleva deklaratsiooni alla kuuluv varustus:
21 (GB) deklariira na eoon otuvastuost, et kõnealune dokument, millele viitakse deklaratsioonis:
22 (I) viššia savo atskaitomybę skelbia, kad įranga, kuriai taikoma ši deklaracija:
23 (LV) ar pilnu atbildību apliecinu, ka tālāk aprakstītais rakstāvs, uz kurām attiecas šī deklarācija:
24 (SK) vyhlasuje na vlastnú zodpovednosť, že zariadenie, na ktoré sa vzťahuje toto vyhlásenie:
25 (TR) taamamen kendi sorumluluğunda oimark üzere bu bildirimli ilgili donanımınm işşığıdeki gibi olduğunu beyan eder:

- 16 megfelelek az alábbi szabvány(ok)nak vagy egyéb irányított dokumentum(ok)nak, ha azokat előírás szerint használják:
17 megfelel a wymogi następujących norm i innych dokumentów normalizacyjnych, pod warunkiem że używane są zgodnie z naszymi instrukcjami:
18 sunt în conformitate cu următorii (următoare) standard(e) (sau al(e) document(e) normative) și condiția ca acestea să fie utilizate în conformitate cu instrucțiunile noastre:
19 skladen z naslednjih standardov in drugih normativ, pod pogojem, da se uporabijo v skladu z našimi navodili:
20 on vastavuses järgmistele standarditele ja/või teiste normatiivse dokumentidega, kui need kasutatakse vastavalt meie juhendile:
21 соответствует на средние стандарты или други нормативны документы, при условии, что он используется согласно нашим инструкциям:
22 atlika žemiau nurodytus standartus ir (ėna) kitus norminius dokumentus su sąlyga, kad yra naudojami pagal mūsų nurodymus:
23 tad, ja šieči atbilstis šioje nurodytiame, arba susijusiuose standartuose ir citen normatiiviu dokumentuim:
24 su v zlože s nasledovnými normami (nebo jinými) normativními dokumenty(ami), za předpokladu, že se používají v sllade s našimi návody:
25 ünün, lalimatlamızda göre kullanılması koşulluyla aşağıdaki standartlar ve norm belirlen belgetele uyumludur:

- 10 Directive, as amended.
11 Directive, med senere ændringer.
12 Directive, med foretagne ændringer.
13 Directive, c tekstre kvanenien.
14 v plátnem znění.
15 Smernice, kako je izmjenjeno.
16 irányelvet/ek) és módosítások rendelkezései.
17 z izjavi, oimark, z ovimi izmenjenimi.
18 Directive, conform alterațiilor.
19 Directive, med senere ændringer.
20 Direktivd kcos muadaltisiga.
21 Директив, с текстре кваненнен.
22 Директив, с поправками.
23 Директив, у то поправкам.
24 Smernice, v plátnem znění.
25 Degjshirnis haterlyte Vornemelker.

- 21 Забелешка * како е изложено в <A> и оценено погледом от согласно Сертификату <C>.
22 Pastaba * kaip nustatyta <A> ir kaip įvertinama nustipėta pagal Serifikatą <C>.
23 Poznamie * ká norádis <A> an atbilsti pozitiivjam vērtējumam saskaņā ar serifikatu <C>.
24 Poznámka * ako bolo uvedené v <A> s pozitívne zistené v súlade s osvedčením <C>.
25 Not * <A> da beiriditig) gibi ve <C> Serifikasima göre tarafından olumlu deđerlendirildiği gibi.

DAIKIN
Jean-Pierre Bauseinck
General Manager
Ostend, 1st of October 2010
3PW40544-5G
DAIKIN EUROPE N.V.
Zandvoordestraat 300, B-8400 Oostende, Belgium

CONTENTS

	Page
1. Introduction.....	1
1.1. General information.....	1
1.2. Scope of this manual	1
1.3. Model identification	2
2. Accessories	2
3. Safety considerations	2
4. Installation of the unit.....	3
4.1. Selecting installation location.....	3
4.2. Precautions on installation	5
4.3. Dimensions and servicing space	6
4.4. Inspecting, handling and unpacking the unit.....	6
4.5. Drain work.....	7
4.6. Installing the unit.....	7
5. Refrigerant pipe size and allowable pipe length	7
5.1. Selection of piping material.....	7
5.2. Refrigerant pipe size	8
5.3. Allowable pipe length and height difference.....	8
5.4. Guidelines for necessity of a trap.....	8
6. Precautions on refrigerant piping.....	8
6.1. Guidelines for brazing	8
6.2. Guidelines for flare connection.....	9
6.3. Guidelines for handling stop valve	9
7. Piping connection work.....	10
7.1. Refrigerant piping.....	10
7.2. Preventing foreign objects from entering	10
7.3. Leak test and vacuum drying	10
7.4. Precautions when connecting field piping and regarding insulation.....	11
8. Charging refrigerant.....	12
8.1. Important information regarding the refrigerant used	12
8.2. Calculating the additional refrigerant charge	12
8.3. Method for adding refrigerant.....	13
9. Electrical wiring work.....	13
9.1. Precautions on electrical wiring work.....	13
9.2. Internal wiring – Parts table	14
9.3. System overview of field wiring.....	15
9.4. Precautions on wiring of power supply and inter-unit wiring	15
9.5. Specifications of standard wiring components.....	15
10. Start-up and configuration	16
10.1. Pre-operation checks	16
11. Test operation and final check	17
11.1. Final check.....	17
11.2. Test run	17
12. Maintenance and servicing.....	17
12.1. Service precautions	17
12.2. Service mode operation	17
13. Disposal requirements.....	19
14. Unit specifications.....	19



READ THESE INSTRUCTIONS CAREFULLY BEFORE INSTALLATION. KEEP THIS MANUAL IN A HANDY PLACE FOR FUTURE REFERENCE.

IMPROPER INSTALLATION OR ATTACHMENT OF EQUIPMENT OR ACCESSORIES COULD RESULT IN ELECTRIC SHOCK, SHORT-CIRCUIT, LEAKS, FIRE OR OTHER DAMAGE TO THE EQUIPMENT. BE SURE ONLY TO USE ACCESSORIES MADE BY DAIKIN WHICH ARE SPECIFICALLY DESIGNED FOR USE WITH THE EQUIPMENT AND HAVE THEM INSTALLED BY A PROFESSIONAL.

IF UNSURE OF INSTALLATION PROCEDURES OR USE, ALWAYS CONTACT YOUR DEALER FOR ADVICE AND INFORMATION.

The English text is the original instruction. Other languages are translations of the original instructions.

1. INTRODUCTION

1.1. General information

Thank you for purchasing this unit.

The outdoor unit is the air to water Daikin ERSQ or ERRQ heat pump.

ERRQ units include special equipment (insulation, heater sheet, ...) to ensure good operation in areas where low ambient temperature can occur together with high humidity conditions. In such conditions the ERSQ models may experience problems with severe ice build up on the aircooled coil. In case such conditions are expected, the ERRQ must be installed instead. These models contain countermeasures (insulation, heater sheet, ...) to prevent freeze up.

NOTE



An ERSQ or ERRQ outdoor unit can only be connected with the EKHBRD indoor unit.

Possible options

	Heater sheet	Drain socket
ERSQ_V1 + Y1	Optional kit ^(a)	Optional kit ^(a)
ERRQ_V1 + Y1	Standard	Use prohibited

(a) Combination of both options is prohibited.

For ERSQ models an optional bottom plate heater kit EKBPH16A can be connected to the outdoor unit. Refer to the installation manual of the bottom plate heater kit for further details.

Snow cover	
ERRQ	EK016SNC

1.2. Scope of this manual

This installation manual describes the procedures for unpacking, installing and connecting all ERSQ or ERRQ outdoor unit models.

NOTE







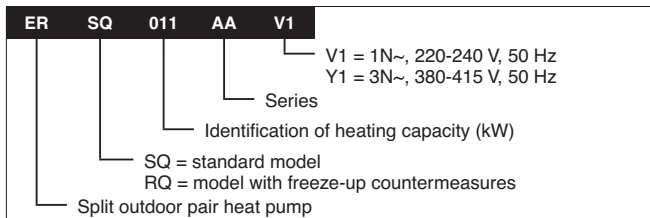

The installation of the EKHBRD indoor unit is described in the indoor unit installation manual.

1.3. Model identification

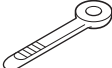

2. ACCESSORIES

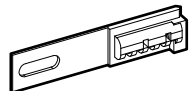
- Check if the following accessories are included with the unit

Installation manual	1	
Cable tie	2	
Fluorinated greenhouse gases label	1	
Multilingual fluorinated greenhouse gases label	1	
Screw (M4x12)	1	
Thermistor fixing plate (for ERRQ only, spare)	1	
Thermistor fixture (for ERRQ only, spare)	1	

See the figure below for the location of the accessories.

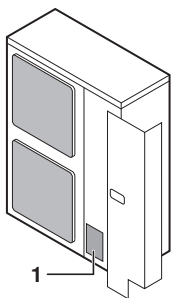

1 Accessories

3. SAFETY CONSIDERATIONS

The precautions listed here are divided into the following two types. Both cover very important topics, so be sure to follow them carefully.



WARNING

If the warning is not observed, it may cause serious casualties.

CAUTION

If the caution is not observed, it may cause injury or damage to the equipment.

Warning

- Ask your dealer or qualified personnel to carry out installation work. Do not install the machine by yourself. Improper installation may result in water leakage, electric shocks or fire.
- Perform installation work in accordance with this installation manual. Improper installation may lead to water leakage, electric shocks or fire.
- Be sure to use only the specified accessories and parts for installation work. Failure to use the specified parts may result in water leakage, electric shocks, fire, or the unit falling.
- Install the unit on a foundation that can withstand its weight. Insufficient strength may result in the fall of equipment and causing injury.
- Carry out the specified installation work in consideration of strong winds, typhoons, or earthquakes. Improper installation work may result in accidents due to fall of equipment.
- Make certain that all electrical work is carried out by qualified personnel according to the local laws and regulations and this installation manual, using a separate circuit. Insufficient capacity of the power supply circuit or improper electrical construction may lead to electric shocks or fire.
- Make sure that all wiring is secure, using the specified wires and ensuring that external forces do not act on the terminal connections or wires. Incomplete connection or fixing may cause a fire.
- When wiring between the indoor and outdoor units, and wiring the power supply, form the wires so that the frontside panel can be securely fastened. If the frontside panel is not in place, the terminals may overheat and electric shocks or a fire may be caused.
- If refrigerant gas leaks during installation work, ventilate the area immediately. Toxic gas may be produced if refrigerant gas comes into contact with fire.
- After completing the installation work, check to make sure that there is no leakage of refrigerant gas. Toxic gas may be produced if refrigerant gas leaks into the room and comes into contact with a source of fire, such as a fan heater, stove or cooker.
- Before touching electric terminal parts, turn off power switch.

Caution

- For use of units in applications with temperature alarm settings it is advised to foresee a delay of 10 minutes for signalling the alarm in case the alarm temperature is exceeded. The unit may stop for several minutes during normal operation for "defrosting of the indoor unit" or when in "thermostat-stop" operation.
- Live parts can be easily touched by accident. Never leave the unit unattended during installation or servicing when the service panel is removed.
- Earth the unit. Earth resistance should be according to national regulations. Do not connect the earth wire to gas or water pipes, lightning conductor or telephone earth wire. Incomplete grounding may cause electric shocks. 
- Gas pipe. Ignition or explosion may occur if the gas leaks.
- Water pipe. Hard vinyl tubes are not effective earths.
- Lightning conductor or telephone earth wire. Electric potential may rise abnormally if struck by a lightning bolt.
- Be sure to install an earth leakage circuit breaker. Failure to install an earth leakage circuit breaker may cause electric shocks and fire.
- Install drain piping according to this installation manual to ensure good drainage, and insulate the pipe to prevent condensation. See combination table in "[General information on page 1](#)". Improper drain piping may cause water leakage, and make the furnitures get wet.
- Install the indoor and outdoor units, power wire and connecting wire at least 1 meter away from televisions or radios to prevent image interference or noise. (Depending on the radio waves, a distance of 1 meter may not be sufficient to eliminate the noise.)
- Do not rinse the outdoor unit. This may cause electric shocks or fire.
- Do not install the unit in places such as the following:
 - Where there is mist of mineral oil, oil spray or vapour for example a kitchen. Plastic parts may deteriorate, and cause them to fall out or water to leak.
 - Where corrosive gas, such as sulphurous acid gas, is produced. Corrosion of copper pipes or soldered parts may cause the refrigerant to leak.
 - Where there is machinery which emits electromagnetic waves. Electromagnetic waves may disturb the control system, and cause malfunction of the equipment.
 - Where flammable gases may leak, where carbon fiber or ignitable dust is suspended in the air or where volatile flammables, such as thinner or gasoline, are handled. Such gases may cause a fire.
 - Where the air contains high levels of salt such as that near the ocean.
 - Where voltage fluctuates a lot, such as that in factories.
 - In vehicles or vessels.
 - Where acidic or alkaline vapour is present.
- Do not allow a child to mount on the outdoor unit or avoid placing any object on the unit. Falling or tumbling may result in injury.
- Do not touch any refrigerant which has leaked out of refrigerant piping connections. This may result in frostbite.

4. INSTALLATION OF THE UNIT

4.1. Selecting installation location



- Make sure to provide for adequate measures in order to prevent that the outdoor unit be used as a shelter by small animals.
- Small animals making contact with electrical parts can cause malfunctions, smoke or fire. Please instruct the customer to keep the area around the unit clean.

- 1 Select an installation site where the following conditions are satisfied and that meets with your customer's approval.
 - Places which are well-ventilated.
 - Places where the unit does not bother next-door neighbours.
 - Safe places which can withstand the unit's weight and vibration and where the unit can be installed level.
 - Places where there is no possibility of flammable gas or product leak.
 - The equipment is not intended for use in a potentially explosive atmosphere.
 - Places where servicing space can be well ensured.
 - Places where the indoor and outdoor units' piping and wiring lengths come within the allowable ranges.
 - Places where water leaking from the unit cannot cause damage to the location (e.g. in case of a blocked drain pipe).
 - Places where the rain can be avoided as much as possible.
- 2 When installing the unit in a place exposed to strong wind, pay special attention to the following.

Strong winds of 5 m/sec or more blowing against the outdoor unit's air outlet causes short circuit (suction of discharge air), and this may have the following consequences:

 - Deterioration of the operational capacity.
 - Frequent frost acceleration.
 - Disruption of operation due to rise of high pressure.
 - When a strong wind blows continuously on the face of the unit, the fan can start rotating very fast until it breaks.

Refer to the figures for installation of this unit in a place where the wind direction can be foreseen.
- Install a baffle plate on the air suction side of the outdoor unit and set the outlet side at a right angle to the direction of the wind:

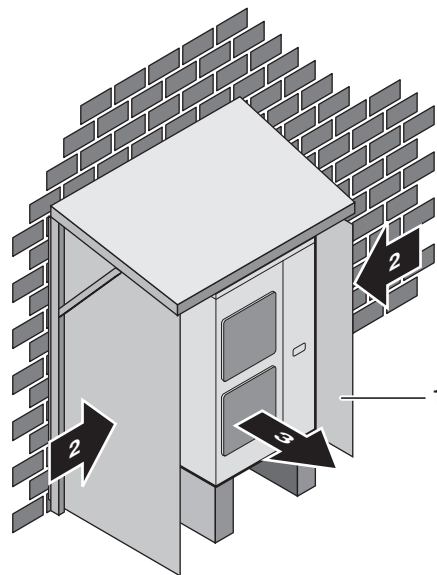

- 1 Baffle plate
- 2 Strong wind
- 3 Discharge air

- Turn the air outlet side toward the building's wall, fence or screen.

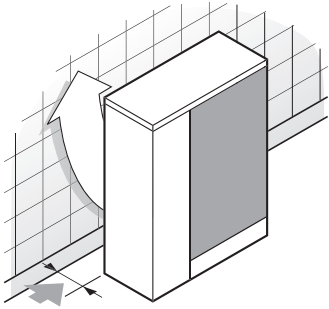

➔ Make sure there is enough room to do the

- Set the outlet side at a right angle to the direction of the wind.

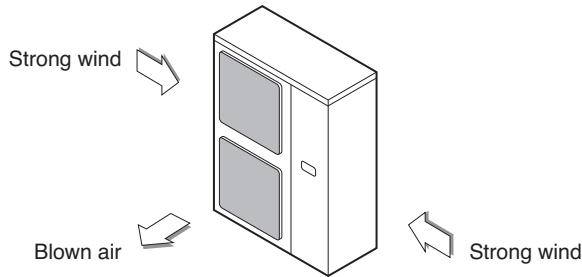

- 3 Prepare a water drainage channel around the foundation, to drain waste water from around the unit (field supply).
- 4 If the water drainage of the unit is not easy, please build up the unit on a foundation of concrete blocks, etc. (the height of the foundation should be maximum 150 mm).
- 5 If you install the unit on a frame, please install a waterproof plate within 150 mm of the underside of the unit in order to prevent the invasion of water from the lower direction.
- 6 When installing the unit in a place frequently exposed to snow, pay special attention to elevate the foundation as high as possible.
- 7 The outdoor unit may short circuit depending on its environment, so use the louvers (field supply).
- 8 If you install the unit on a building frame, please install a waterproof plate (field supply)(within 150 mm of the underside of the unit) or use a drain kit (refer to combination table in "General information" on page 1) in order to avoid the drainwater dripping. (See figure).



The equipment described in this manual may cause electronic noise generated from radio-frequency energy. The equipment complies to specifications that are designed to provide reasonable protection against such interference. However, there is no guarantee that interference will not occur in a particular installation.

It is therefore recommended to install the equipment and electric wires keeping proper distances away from stereo equipment, personal computers, etc... (See figure 2)

- 1 Personal computer or radio
- 2 Indoor unit
- 3 Outdoor unit

In extreme circumstances you should keep distances of 3 m or more and use conduit tubes for power and transmission lines.

Selecting a location in cold climates

Refer to "General information" on page 1.



CAUTION

When operating the outdoor unit in a low outdoor ambient temperature, be sure to follow the instructions described below.

- To prevent exposure to wind, install the outdoor unit with its suction side facing the wall.
- Never install the outdoor unit at a site where the suction side may be exposed directly to wind.
- To prevent exposure to wind, install a baffle plate on the air discharge side of the outdoor unit.
- In heavy snowfall areas it is very important to select an installation site where the snow will not affect the unit. If lateral snowfall is possible, make sure that the heat exchanger coil is not affected by the snow (if necessary construct a lateral canopy).

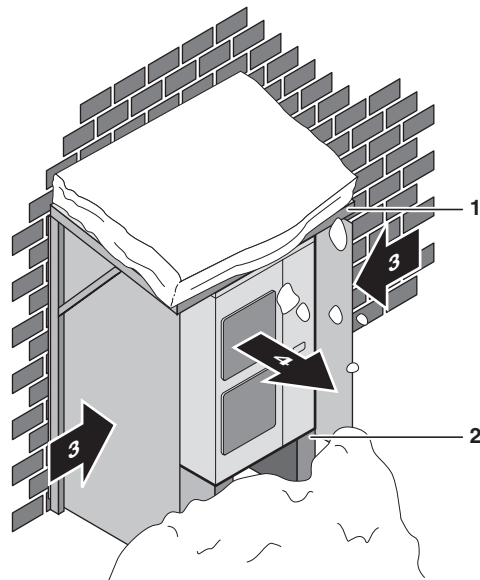

- 1 Construct a large canopy.
- 2 Construct a pedestal. Install the unit high enough off the ground to prevent burying in snow.
- 3 Strong wind
- 4 Discharge air

NOTE



If the installation of a canopy is not possible, the optional snow cover (EK016SNC) shall be installed.

- For ERRQ only. Follow the procedure as described below for modifying the position of the air thermistor (R1T). The thermistor fixture is delivered in the accessory bag.

NOTE



Spare thermistor fixing plate is delivered in the accessory bag.

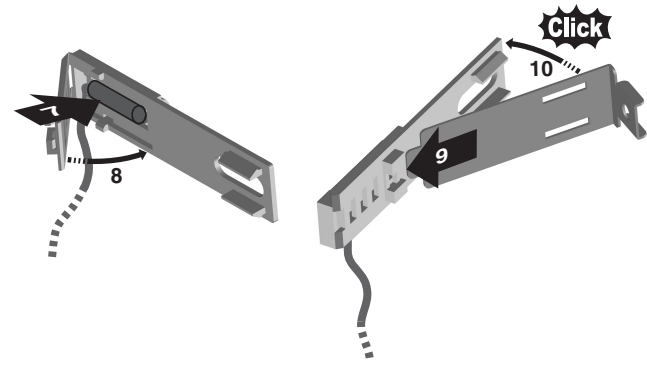
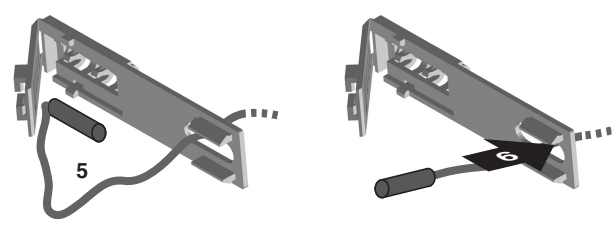
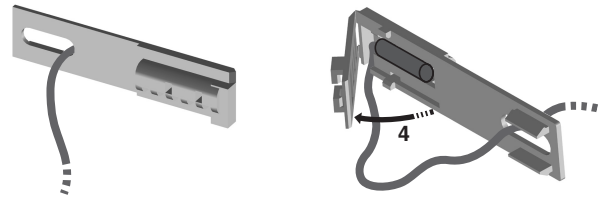
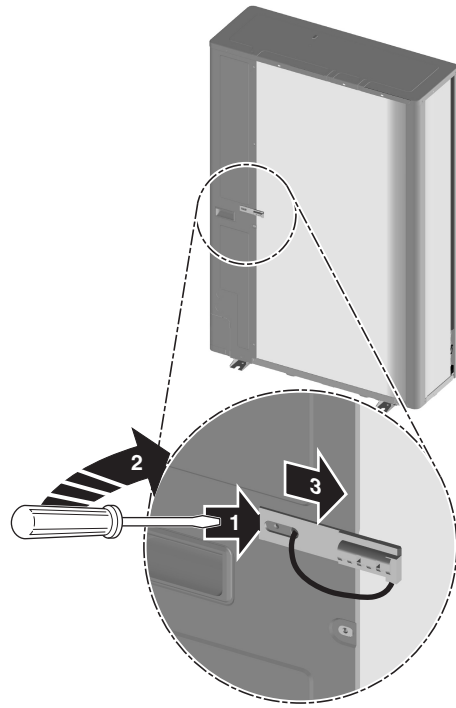
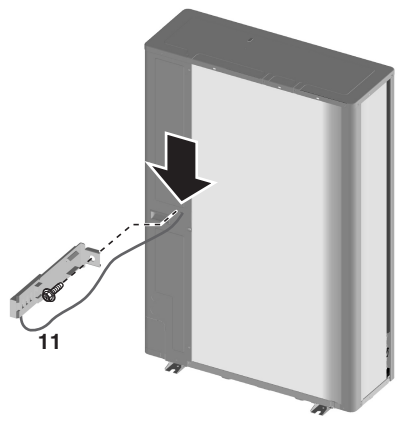
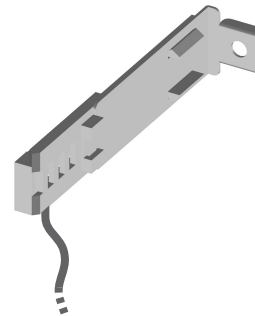

4.2. Precautions on installation

- Check the strength and level of the installation ground so that the unit will not cause any operating vibration or noise after installation.
- In accordance with the foundation drawing in the figure, fix the unit securely by means of the foundation bolts. (Prepare 4 sets of M12 foundation bolts, nuts and washers each which are available on the market.)
- It is best to screw in the foundation bolts until their length are 20 mm from the foundation surface.

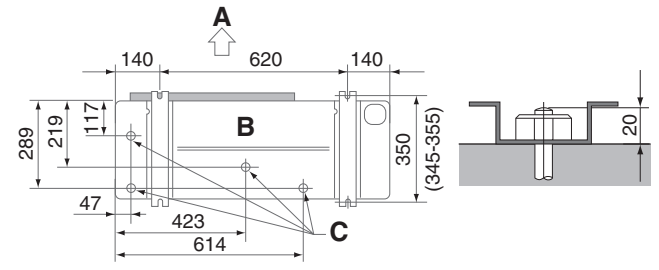

- A Discharge side
- B Bottom view (mm)
- C Drain hole

4.3. Dimensions and servicing space

- The connection piping outlet direction in the installation shown in figure 4 is frontward or downward. The unit of numeric values is mm.
- When routing the piping backward, secure space of ≥ 250 mm on the right side of the unit.

(A) In case of non-stacked installation (See figure 4)

- | | | | |
|--|-------------------------|---|--|
| | Suction side obstacle | 1 | In these cases, close the bottom of the installation frame to prevent the discharged air from being bypassed |
| | Discharge side obstacle | | |
| | Left side obstacle | 2 | In these cases, only 2 units can be installed. |
| | Right side obstacle | 3 | In these cases, no restriction of height L1. |
| | Top side obstacle | | This situation is not allowed |
| | Obstacle is present | | |

(B) In case of stacked installation

1. In case obstacles exist in front of the outlet side.

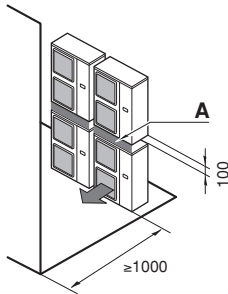

2. In case obstacles exist in front of the air inlet.

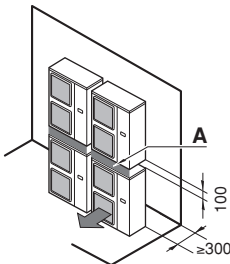

NOTE



- Do not stack more than one unit.
- About 100 mm is required as the dimension for laying the upper outdoor unit's drain pipe.
- Get the portion A sealed so that air from the outlet does not bypass.

(C) In case of multiple-row installation (for roof top use, etc.)

1. In case of installing one unit per row.

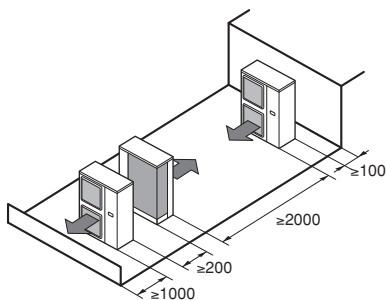

2. In case of installing multiple units (2 units or more) in lateral connection per row.

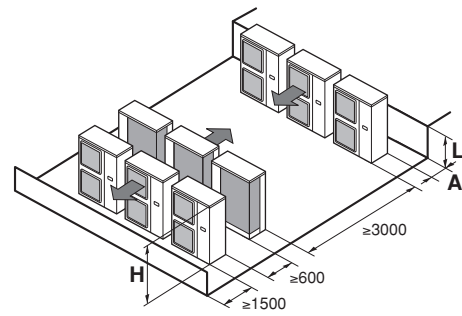

Relation of dimensions between H, A and L is shown in the table below.

	L	A
$L \leq H$	$0 < L \leq 1/2H$	250
	$1/2H < L \leq H$	300
$H < L$	Installation impossible	

4.4. Inspecting, handling and unpacking the unit

Handling the unit

As shown in the figure, bring the unit slowly by grabbing the left and right grips.

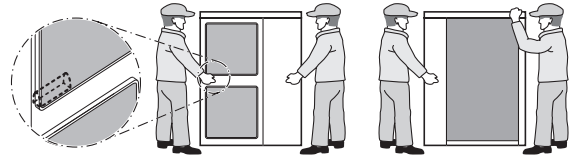

Place your hands on the corner instead of holding the suction inlet in the side of the casing, otherwise the casing could be deformed.



Take care not to let hands or objects come in contact with rear fins.

Installation method for prevention of falling over

If it is necessary to prevent the unit from falling over, install as shown in the figure.

- prepare all 4 wires as indicated in the drawing
- unscrew the top plate at the 4 locations indicated A and B
- put the screws through the nooses and screw them back tight

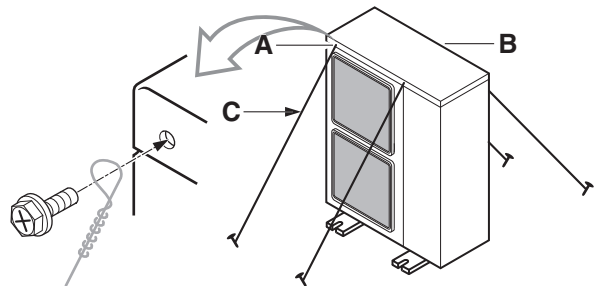

- A location of the 2 fixation holes on the front side of the unit
- B location of the 2 fixation holes on the rear side of the unit
- C wires: field supply

Method for removing transportation stay

The yellow transportation stay installed over the compressor leg for protecting the unit during transport must be removed. Proceed as shown in [figure 3](#) and described below.

- A Compressor
- B Fixing nut
- C Transportation stay

- 1 Slightly loosen the fixing nut (B).
- 2 Remove the transportation stay (C) as shown in [figure 3](#).
- 3 Tighten the fixing nut (B) again.



CAUTION

If the unit is operated with the transportation stay attached, abnormal vibration or noise may be generated.

4.5. Drain work

Check in the combination table under "General information" on [page 1](#) whether drain work is allowed. In case drain work on your unit is allowed and the installation site requires drain work, then follow the guidelines below.

- Drain kits for drainage are available as option.
- If drain work from the outdoor unit causes trouble (for example, if the drain water may splash on people) provide the drain piping using a drain socket (optional).
- Make sure the drain works properly.

NOTE



If drain holes of the outdoor unit are covered by a mounting base or by floor surface, raise the unit in order to provide a free space of more than 100 mm under the outdoor unit.

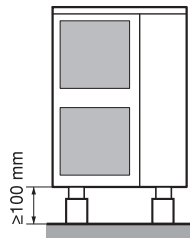

4.6. Installing the unit



Since design pressure is 4.0 MPa or 40 bar, pipes of larger wall thickness may be required. Refer to paragraph "5.1. Selection of piping material" on [page 7](#).

Precautions for R410A

- The refrigerant requires strict cautions for keeping the system clean, dry and tight.
 - Clean and dry
Foreign materials (including mineral oils or moisture) should be prevented from getting mixed into the system.
 - Tight
Read "6. Precautions on refrigerant piping" on [page 8](#) carefully and follow these procedures correctly.
- Since R410A is a mixed refrigerant, the required additional refrigerant must be charged in its liquid state. (If the refrigerant is in state of gas, its composition changes and the system will not work properly).
- The connected indoor unit must be the EKHBRD unit.

Installation

- For installation of the indoor unit, refer to the indoor unit installation manual.
- Refer to the Engineering Data Book for the complete list of technical and electrical specifications.
- Never operate the unit with the discharge pipe thermistor (R2T), suction pipe thermistor (R3T) and pressure sensors (S1NPH, S1NPL) removed. Such operation may burn out the compressor.
- Be sure to confirm the model name and the serial no. of the outer (front) plates when attaching/detaching the plates to avoid mistakes.
- When closing the service panels, take care that the tightening torque does not exceed 4.1 N·m.

5. REFRIGERANT PIPE SIZE AND ALLOWABLE PIPE LENGTH



- Piping and other pressure containing parts shall comply with the applicable national and international regulations and shall be suitable for refrigerant. Use phosphoric acid deoxidised seamless copper for refrigerant.
- Installation shall be done by a licensed refrigerant technician, the choice of materials and installation shall comply with national and international regulations. In Europe the EN378 is the application standard that shall be used.



To persons in charge of piping work:

- Be sure to open the stop valve after piping installing and vacuuming is complete. (Running the system with the valve closed may break the compressor.)
- It is forbidden to discharge refrigerant into the atmosphere. Collect the refrigerant in accordance with the freon collection and destruction law.

5.1. Selection of piping material

- Foreign materials inside pipes (including oils for fabrication) must be ≤ 30 mg/10 m.
- Construction material: phosphoric acid deoxidized seamless copper for refrigerant.
- Temper grade: use piping with temper grade in function of the pipe diameter as listed in table below.
- The pipe thickness of the refrigerant piping should comply with relevant local and national regulations. The minimal pipe thickness for R410A piping must be in accordance with the table below.

Pipe size (mm)	Temper grade of piping material	Minimal thickness (mm)
Ø9.5	O	0.80
Ø15.9	O	1.00

O = Annealed

- In case the required pipe sizes (inch sizes) are not available, it is also allowed to use other diameters (mm sizes), taken the following into account:
 - select the pipe size nearest to the required size.
 - use the suitable adapters for the change-over from inch to mm pipes (field supply).

5.2. Refrigerant pipe size

The pipes between outdoor unit and indoor unit should have the same size as the outdoor connections.

Refrigerant pipe size (mm)	
Gas pipe	Ø15.9
Liquid pipe	Ø9.5

5.3. Allowable pipe length and height difference

See the table below concerning lengths and heights. Refer to [figure 1](#). Assume that the longest line in the figure corresponds with the actual longest pipe, and the highest unit in the figure corresponds with the actual highest unit.

Allowable pipe length (m)		
Maximum total one-way piping length ^(a)	L	50 (95)
Maximum height between indoor and outdoor	H	30
Chargeless length	L	≤10

(a) Parenthesized figure represents the equivalent length.

5.4. Guidelines for necessity of a trap

Since there is fear of the oil held inside the riser piping flowing back into the compressor when stopped and causing liquid compression phenomenon, or cases of deterioration of oil return, it will be necessary to provide a trap at an appropriate place in the riser gas piping.

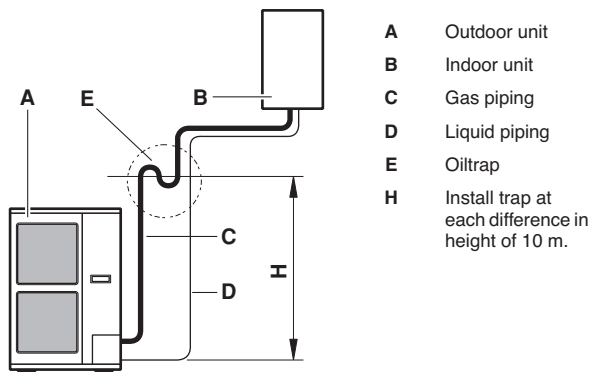

A trap is not necessary when the outdoor unit is installed in a higher position than the indoor unit.

6. PRECAUTIONS ON REFRIGERANT PIPING

- Do not allow anything other than the designated refrigerant to get mixed into the freezing cycle, such as air, etc. If any refrigerant gas leaks while working on the unit, ventilate the room thoroughly right away.

- Use R410A only when adding refrigerant
Installation tools:

Make sure to use installation tools (gauge manifold charge hose, etc.) that are exclusively used for R410A installations to withstand the pressure and to prevent foreign materials (e.g. mineral oils and moisture) from mixing into the system.

Vacuum pump:

Use a 2-stage vacuum pump with a non-return valve

Make sure the pump oil does not flow oppositely into the system while the pump is not working.

Use a vacuum pump which can evacuate to -100.7 kPa (5 Torr, -755 mm Hg).

- In order to prevent dirt, liquid or dust from entering the piping, cure the piping with a pinch or taping.

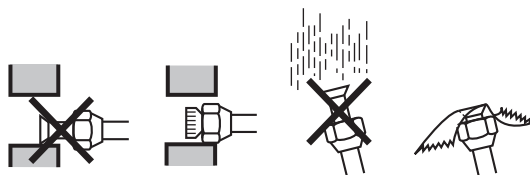

	Installation period	Protection method
House icon	More than a month	Pinch the pipe
	Less than a month	Pinch or tape the pipe
House icon	Regardless of the period	

Great caution is needed when passing copper tubes through walls.

- For handling of stop valves, refer to "6.3. Guidelines for handling stop valve" on page 9.
- Only use the flare nuts included with the unit. Using different flare nuts may cause the refrigerant to leak.
- Ensure that the field piping and connections are not subjected to stress.
- Use appropriate fire resistant piping insulation according to national regulations.

6.1. Guidelines for brazing

- Make sure to blow through with nitrogen when brazing. Blowing through with nitrogen prevents the creation of large quantities of oxidized film on the inside of the piping. An oxidized film adversely affects valves and compressors in the refrigerating system and prevents proper operation.
- The nitrogen pressure should be set to 0.02 MPa (i.e., just enough so it can be felt on the skin) with a pressure-reducing valve.

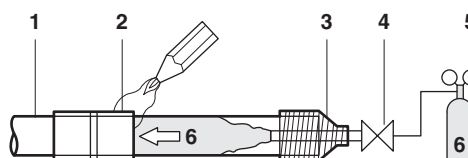

- Refrigerant piping
- Part to be brazed
- Taping
- Hands valve
- Pressure-reducing valve
- Nitrogen

- Do not use anti-oxidants when brazing the pipe joints. Residue can clog pipes and break equipment.
- Do not use flux when brazing copper-to-copper refrigerant piping. Use phosphor copper brazing filler alloy (BCuP) which does not require flux.
- Flux has an extremely harmful influence on refrigerant piping systems. For instance, if chlorine based flux is used, it will cause pipe corrosion or, in particular, if the flux contains fluorine, it will deteriorate the refrigerant oil.

6.2. Guidelines for flare connection

- Flares should not be re-used. New ones should be made in order to prevent leaks.
- Use a pipe cutter and flare tool suitable for the refrigerant used.
- Only use the annealed flare nuts included with the unit. Using different flare nuts may cause the refrigerant to leak.
- Please refer to the table for flaring dimensions and tightening torques (too much tightening will result in splitting the flare).

Piping size (mm)	Tightening torque (N·m)	Flare dimensions A (mm)	Flare shape (mm)
Ø9.5	33~39	12.8~13.2	
Ø15.9	63~75	19.4~19.7	

- When connecting the flare nut, coat the flare inner surface with ether oil or ester oil and initially tighten 3 or 4 turns by hand before tightening firmly.

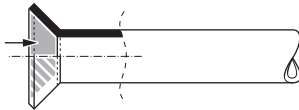

- When loosening a flare nut, always use two wrenches together. When connecting the piping, always use a spanner and torque wrench together to tighten the flare nut to prevent flare nut cracking and leaks.

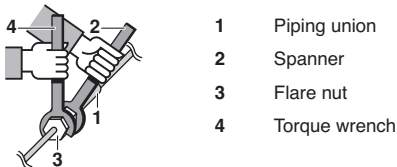

Not recommended, but in case of emergency

Should you be forced to connect the piping without a torque wrench, follow the following installation method:

- Tighten the flare nut using a spanner until the tightening torque suddenly increases.
- From that position further tighten the flare nut the angle listed below:

Piping size (mm)	Further tightening angle (degrees)	Recommended arm length of spanner (mm)
Ø9.5	60~90	±200
Ø15.9	30~60	±300

6.3. Guidelines for handling stop valve

Cautions on handling the stop valve

- Make sure to keep both stop valves open during operation.
- The figure below shows the name of each part required in handling the stop valve.

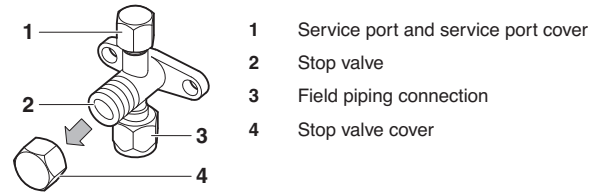

- The stop valve is factory closed.
- Do not apply excessive force to the stop valve. Doing so may break the valve body. Since the stop valve mounting plate may be deformed if only a torque wrench is used to loosen or tighten the flare nut, always make sure to secure the stop valve with a spanner, then loosen or tighten the flare nut with a torque wrench. Do not place the spanner on the stop valve cover, as this could cause a refrigerant leak.

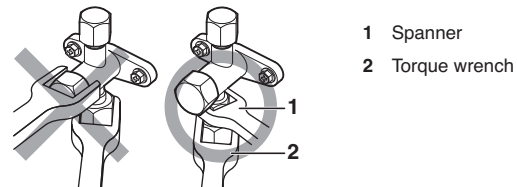

- The operating pressure at the refrigerant side can be low (for example, heating operation when outdoor temperature is low), sufficiently seal the flare nut in the stop valve on the gas line with silicon sealant to prevent freezing.

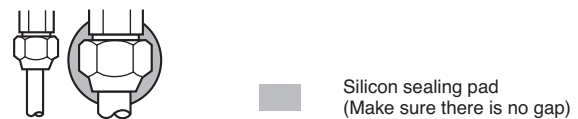

Opening/closing the stop valve

Opening the stop valve

- Remove the valve cover.
- Insert a hexagon wrench (liquid side: 4 mm/gas side: 6 mm) into the stop valve and turn the stop valve counterclockwise.
- When the stop valve cannot be turned any further, stop turning. The valve is now open.

Closing the stop valve

- Remove the valve cover.
- Insert a hexagon wrench (liquid side: 4 mm/gas side: 6 mm) into the stop valve and turn the stop valve clockwise.
- When the stop valve cannot be turned any further, stop turning. The valve is now closed.

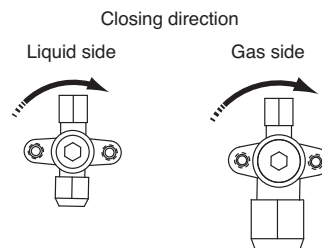

Cautions on handling the stop valve cover

- The stop valve cover is sealed where indicated by the arrow. Take care not to damage it.
- After handling the stop valve, make sure to tighten the stop valve cover securely. For the tightening torque, refer to the table below.
- Check for refrigerant leaks after tightening the stop valve cover.

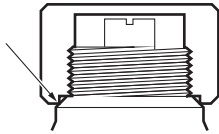

Cautions on handling the service port

- Always use a charge hose equipped with a valve depressor pin, since the service port is a Schrader type valve.
- After handling the service port, make sure to tighten the service port cover securely. For the tightening torque, refer to the table below.
- Check for refrigerant leaks after tightening the service port cover.

Tightening torques

Item	Tightening torque (N·m)
Stop valve cover, liquid side	13.5~16.5
Stop valve cover, gas side	22.5~27.5
Service port cover	11.5~13.9

7. PIPING CONNECTION WORK

7.1. Refrigerant piping

- Field pipes can be installed in four directions.

Figure - Field pipes in four directions (See figure 5)

- 1 Drill
 - 2 Center area around knockout hole
 - 3 Knockout hole
 - 4 Slit
 - 5 Connecting pipe liquid (field supply)
 - 6 Bottom frame
 - 7 Front plate
 - 8 Pipe outlet plate
 - 9 Screw front plate
 - 10 Pipe outlet plate screw
- A Forward
B Backward
C Sideways
D Downward

When connecting the piping in the lateral direction (on the rear), remove the piping cover (rear) in reference to figure 7.

- 1 Piping cover (rear)

- To install the connecting pipe to the unit in a downward direction, make a knockout hole by penetrating the center area around the knockout hole using a Ø6 mm drill. (See figure 5).
- Cutting out the two slits makes it possible to install as shown in figure 5. (Use a metal saw to cut out the slits.)
- After knocking out the knock-out, it is recommended to apply repair paint to the edge and the surrounding end surfaces to prevent rusting.

7.2. Preventing foreign objects from entering

Plug the pipe through-holes with putty or insulating material (field supply) to stop up all gaps, as shown in the figure.

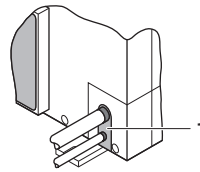

- 1 Putty or insulating material (field supply)

Insects or small animals entering the outdoor unit may cause a short circuit in the electrical box.

7.3. Leak test and vacuum drying

When all piping work is complete and the outdoor unit is connected to the indoor unit, it is necessary to (a) check for any leakages in the refrigerant piping and (b) to perform vacuum drying to remove all moisture in the refrigerant piping.

If there is a possibility of moisture being present in the refrigerant piping (for example, rainwater may have entered the piping), first carry out the vacuum drying procedure below until all moisture has been removed.

General guidelines

- All piping inside the unit has been factory tested for leaks.
- Use a 2-stage vacuum pump with a non-return valve which can evacuate to a gauge pressure of -100.7 kPa (5 Torr absolute, -755 mm Hg).
- Connect the vacuum pump to **both** the service port of the gas stop valve and the liquid stop valve to increase efficiency.



- Do not purge the air with refrigerants. Use a vacuum pump to evacuate the installation. No additional refrigerant is provided for air purging.
- Make sure that the gas stop valve and liquid stop valve are firmly closed before performing the leak test or vacuum drying.

Setup

(See figure 6)

- 1 Pressure reducing valve
- 2 Nitrogen
- 3 Siphon system
- 4 Vacuum pump
- 5 Valve A
- 6 Gas line stop valve
- 7 Liquid line stop valve
- 8 Stop valve service port
- 9 Charge hose

Leak test

The leak test must satisfy specification EN 378-2.

1 Vacuum leak test

- 1.1 Evacuate the system from the liquid and gas piping to -100.7 kPa (5 Torr).
- 1.2 Once reached, turn off the vacuum pump and check that the pressure does not rise for at least 1 minute.
- 1.3 Should the pressure rise, the system may either contain moisture (see vacuum drying below) or have leaks.

2 Pressure leak test

- 2.1 Break the vacuum by pressurizing with nitrogen gas to a minimum gauge pressure of 0.2 MPa (2 bar). Never set the gauge pressure higher than the maximum operation pressure of the unit, i.e. 4.0 MPa (40 bar).
- 2.2 Test for leaks by applying a bubble test solution to all piping connections.



Make sure to use a recommended bubble test solution from your wholesaler.

Do not use soap water, which may cause cracking of flare nuts (soap water may contain salt, which absorbs moisture that will freeze when the piping gets cold), and/or lead to corrosion of flared joints (soap water may contain ammonia which causes a corrosive effect between the brass flare nut and the copper flare).

2.3 Discharge all nitrogen gas.

Vacuum drying

To remove all moisture from the system, proceed as follows:

1. Evacuate the system for at least 2 hours to a target vacuum of -100.7 kPa.
2. Check that, with the vacuum pump turned off, the target vacuum is maintained for at least 1 hour.
3. Should you fail to reach the target vacuum within 2 hours or maintain the vacuum for 1 hour, the system may contain too much moisture.
4. In that case, break the vacuum by pressurizing with nitrogen gas to a gauge pressure of 0.05 MPa (0.5 bar) and repeat steps 1 to 3 until all moisture has been removed.
5. The stop valves can now be opened, and/or additional refrigerant can be charged (see "8.3. Method for adding refrigerant" on page 13).



After opening the stop valve, it is possible that the pressure in the refrigerant piping does not rise. This might be caused by e.g. the closed state of the expansion valve in the outdoor unit circuit, but does not present any problem for correct operation of the unit.

7.4. Precautions when connecting field piping and regarding insulation

- Be careful not to let the indoor and outdoor field piping come into contact with the compressor terminal cover. If the liquid-side piping insulation might come into contact with it, adjust the height as shown in the figure below. Also, make sure the field piping does not touch the bolts or outer panels of the compressor.
- When the outdoor unit is installed above the indoor unit the following can occur:
The condensated water on the stop valve can move to the indoor unit. To avoid this, please cover the stop valve with sealing material.
- If the temperature is higher than 30°C and the humidity is higher than RH 80%, then the thickness of the sealing materials should be at least 20 mm in order to avoid condensation on the surface of the sealing.
- Be sure to insulate the liquid and gas-side field piping.



Any exposed piping may cause condensation or burns if touched.

(The highest temperature that the gas-side piping can reach is around 120°C , so be sure to use insulating material which is heat resistant.)

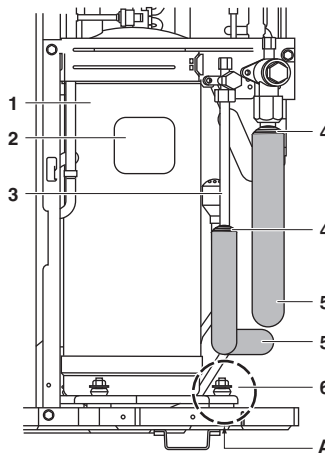

- 1 Compressor
- 2 Terminal cover
- 3 Indoor and outdoor field piping
- 4 Corking, etc.
- 5 Insulation material (field supply)
- 6 Bolts
- A Be careful with pipe, bolt and outer panel connections

8. CHARGING REFRIGERANT



- When servicing the unit requires the refrigerant system to be opened, treatment and evacuation of refrigerant must be done in accordance with relevant local and national legislation.
- Refrigerant cannot be charged until field wiring has been completed.
- Refrigerant may only be charged after performing the leak test and the vacuum drying (see above).
- When charging a system, care shall be taken that its maximum permissible charge is never exceeded, in view of the danger of liquid hammer.
- Charging with an unsuitable substance may cause explosions and accidents, so always ensure that the appropriate refrigerant (R410A) is charged.
- Refrigerant containers shall be opened slowly.
- Always use protective gloves and protect your eyes when charging refrigerant.
- When performing service on the unit requiring the refrigerant system to be opened, refrigerant must be evacuated according to local regulations.
- When the power is on, please close the front panel when leaving the unit.



To avoid compressor breakdown. Do not charge the refrigerant more than the specified amount.

- This outdoor unit is factory charged with refrigerant and depending on pipe sizes and pipe lengths some systems require additional charging of refrigerant. See "[Calculating the additional refrigerant charge](#)" on page 12.
- In case re-charge is required, refer to the nameplate of the unit. The nameplate states the type of refrigerant and necessary amount.

8.1. Important information regarding the refrigerant used

This product contains fluorinated greenhouse gases covered by the Kyoto Protocol. Do not vent gases into the atmosphere.

Refrigerant type: R410A

GWP⁽¹⁾ value: 1975

⁽¹⁾ GWP = global warming potential

Please fill in with indelible ink,

- ① the factory refrigerant charge of the product,
- ② the additional refrigerant amount charged in the field and
- ①+② the total refrigerant charge

on the fluorinated greenhouse gases label supplied with the product.

The filled out label must be adhered on the inside of the product and in the proximity of the product charging port (e.g. on the inside of the service cover).

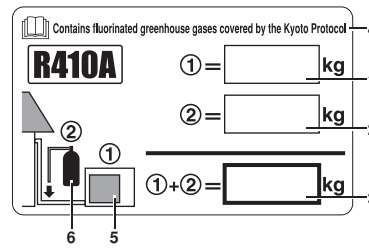

- 1 factory refrigerant charge of the product: see unit name plate
- 2 additional refrigerant amount charged in the field
- 3 total refrigerant charge
- 4 Contains fluorinated greenhouse gases covered by the Kyoto Protocol
- 5 outdoor unit
- 6 refrigerant cylinder and manifold for charging

NOTE



National implementation of EU regulation on certain fluorinated greenhouse gases may require to provide the appropriate official national language on the unit. Therefore, an additional multilingual fluorinated greenhouse gases label is supplied with the unit.

Sticking instructions are illustrated on the backside of that label.

8.2. Calculating the additional refrigerant charge



Piping length is the one way length of gas or liquid piping whichever is the longest.

It is not necessary to charge additionally if the piping length is under 10 m.

If the piping length is over 10 m please determine the additional amount of refrigerant to be charged using the table below.

Table 1: Additional charging of refrigerant <unit: kg>

Refrigerant piping length				
3~10 m	10~20 m	20~30 m	30~40 m	40~50 m
(a)	0.54	1.08	1.62	2.16

(a) Additional charge not required

Complete recharging

In case complete recharging is required (after a leak, etc.), refer to the table below to determine the necessary amount of refrigerant.



Before recharging, make sure to execute vacuum drying of the internal piping of the unit as well. To do so, use the internal service port of the unit. Do NOT use the service ports located on the stop valve (see "[6.3. Guidelines for handling stop valve](#)" on page 9), since vacuum drying can not be performed properly from these ports.

Outdoor units have 1 port on the piping. It is between the heat exchanger and the 4-way valve.

Table 2: Total charging amount <unit: kg>

Refrigerant piping length				
3~10 m	10~20 m	20~30 m	30~40 m	40~50 m
4.5	5.0	5.6	6.1	6.7

8.3. Method for adding refrigerant

Precautions when adding R410A

- Make sure to charge the refrigerant in liquid state to the liquid pipe. Since R410A is a mixed refrigerant, its composition changes if charged in its gaseous state and normal system operation would then no longer be assured.
- Before charging, check whether the refrigerant cylinder has a siphon attached or not and position the cylinder accordingly.

Filling using a cylinder with a siphon attached
Charge the liquid refrigerant with the cylinder in upright position.

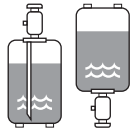

Filling using a cylinder without a siphon attached
Charge the liquid refrigerant with the cylinder in up-side-down position.

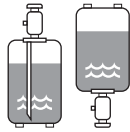

How to connect the tank?

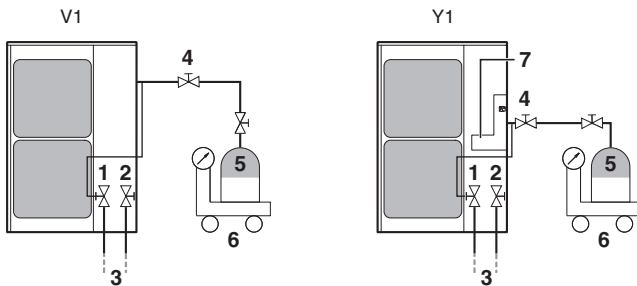

- 1 Liquid line stop valve
- 2 Gas line stop valve
- 3 To indoor unit
- 4 Valve A
- 5 R410A tank
- 6 Measuring instrument
- 7 Pipe fixing plate

When the refrigerant tank is connected and the specified operation is performed, the appropriate amount of refrigerant will be charged into the system. The refrigerant must be charged according to the procedure described below.

Charging while the outdoor unit is at a standstill

See the figure in "How to connect the tank?" on page 13.

- 1 Determine the weight of refrigerant to be charged additionally referring to the item "Additional refrigerant charge" in "Calculating the additional refrigerant charge" on page 12 and fill in the amount in the "Additional refrigerant charge label" attached to the unit.
- 2 After the vacuum drying is finished, open valve A and charge the additional refrigerant in its liquid state through the service port on the liquid stop valve taking into account following instructions:
 - Turn on the power supply of the outdoor unit and indoor unit (main circuit breaker on).
 - Check that gas and liquid stop valves are closed.
 - Stop the compressor and charge the specified weight of refrigerant.



To avoid compressor breakdown. Do not charge the refrigerant more than the specified amount.

9. ELECTRICAL WIRING WORK



All field wiring and components must be installed by a licensed electrician and must comply with relevant European and national regulations.













To persons in charge of electrical wiring work:

Do not operate the unit until the refrigerant piping is complete. (Running it before the piping is ready will break the compressor.)

9.1. Precautions on electrical wiring work

- Before obtaining access to terminal devices, all supply circuits must be interrupted.
- Use only copper wires.
- Do not turn on the main switch until all the wiring is completed.
- Never squeeze bundled cables into a unit.
- Secure the electrical wiring with clamping material as shown in figure 8 so that it does not come in contact with the piping, particularly on the high-pressure side. Make sure no external pressure is applied to the terminal connectors.
- When installing the earth leakage breaker make sure that it is compatible with the inverter (resistant to high frequency electrical noise) to avoid unnecessary opening of the earth leakage breaker.
- As this unit is equipped with an inverter, installing a phase advancing capacitor not only will deteriorate power factor improvement effect, but also may cause capacitor abnormal heating accident due to high-frequency waves. Therefore, never install a phase advancing capacitor.
- Follow the "electrical wiring diagram" when carrying out any electrical wiring.
- Always ground wires. (In accordance with national regulations of the pertinent country.)
- Do not connect the ground wire to gas pipes, sewage pipes, lightning rods, or telephone ground wires.
 - Combustion gas pipes: can explode or catch fire if there is a gas leak.
 - Sewage pipes: no grounding effect is possible if hard plastic piping is used.
 - Telephone ground wires and lightning rods: dangerous when struck by lightning due to abnormal rise in electrical potential in the grounding.
- This unit uses an inverter, and therefore generates noise, which will have to be reduced to avoid interfering with other devices. The outer casing of the product may take on an electrical charge due to leaked electrical current, which will have to be discharged with the grounding.
- For Y1 models only: Make sure to connect power supply cables in normal phase. If connected in reverse phase, the remote controller of the indoor unit indicates "L1" and the equipment cannot operate. Change any two of the three power supply cables (L1, L2, L3) to correct phase. (Refer to the installation manual of the indoor unit for more details.)
- A main switch or other means for disconnection having a contact separation in all poles, shall be incorporated in the fixed wiring in accordance with relevant local and national regulations.

9.2. Internal wiring – Parts table

L.....	Live
N.....	Neutral
	Terminal strip
	Field wiring
	Terminal strip
	Connector
	Protective earth
	Connection
	Relay connector
	Functional earthing
	Terminal
	Movable connector
	Fixed connector
BLU.....	Blue
BRN.....	Brown
GRN.....	Green
RED.....	Red
WHT.....	White
YLW.....	Yellow
ORG.....	Orange
BLK.....	Black
A1P.....	Printed circuit board (main)
A2P.....#.....	Printed circuit board (inverter)
A2P.....*.....	Printed circuit board (service)
A3P.....*.....	Printed circuit board (noise filter)
BS1~BS5.....	Push button switch (mode, set, return, test, reset)
C1~C3.....	Capacitor
C4.....*.....	Capacitor
DS1.....	Dip switch
E1H.....	Bottom plate heater
E1HC.....	Crankcase heater
F1U,F4U.....*.....	Fuse (T 6.3 A/250 V)
F1U,F2U.....#.....	Fuse (A 31.5 A/500 V)
F3U~F5U.....#.....	Fuse (T 6.3 A/250 V)
F6U.....	Fuse (T 5.0 A/250 V)
FINTH.....*.....	Thermistor (fin)
H1P~H8P.....	Light emitting diode (service monitor orange)
	H2P: Prepare, test: blinking
	H2P: Malfunction detection: light up
HAP (A1P).....	Light emitting diode (service monitor green)
HAP (A2P).....#.....	Light emitting diode (service monitor green)
K1M.....	Magnetic contactor (M1C)
K2M.....#.....	Magnetic contactor
K1R.....	Magnetic relay (Y1S)
K2R.....	Magnetic relay (Y2S)
K3R.....	Magnetic relay (Y3S)
K4R.....	Magnetic relay (E1HC)
K5R.....	Magnetic relay
L1R.....	Reactor
L1R,L3R.....#.....	Reactor
M1C.....	Motor (compressor)
M1F.....	Motor (fan) (upper)

M2F.....	Motor (fan) (lower)
PS.....	Switching power supply
Q1DI.....	Field earth leakage breaker (300 mA)
R1,R2.....	Resistor
R1T.....	Thermistor (air)
R2T.....	Thermistor (discharge)
R2T.....#.....	Thermistor (M1C discharge)
R3T.....	Thermistor (suction 1)
R4T.....*.....	Thermistor (heat exchanger)
R4T.....#.....	Thermistor (subcooling heat exchanger)
R5T.....	Thermistor (suction 2)
R6T.....*.....	Thermistor (subcooling heat exchanger)
R6T.....#.....	Thermistor (heat exchanger)
R7T.....	Thermistor (liquid pipe 1)
R8T.....	Thermistor (liquid pipe 2)
R9T.....#.....	Thermistor (power module)
S1NPH.....	Pressure sensor (high)
S1NPL.....	Pressure sensor (low)
S1PH.....	Pressure switch (high)
V1R.....	Power module
V2R.....*.....	Diode module
V2R.....#.....	Power module
V3R.....	Diode module
V1T.....*.....	IGBT (Insulated Gate Bipolar Transistor)
X1M.....	Terminal strip (power supply)
X2M.....	Terminal strip (control)
Y1E.....	Electronic expansion valve (main)
Y3E.....	Electronic expansion valve (subcool)
Y1S.....	Solenoid valve (4 way valve)
Y2S.....	Solenoid valve (hot gas)
Y3S.....	Solenoid valve (unload circuit)
Z1C~Z8C.....*.....	Noise filter (ferrite core)
Z1C~Z7C.....#.....	Noise filter (ferrite core)
Z1F~Z4F.....*.....	Noise filter
Z1F~Z3F.....#.....	Noise filter

Parts table legend

*	For V1 models only
#	For Y1 models only

Notes

- 1 This wiring diagram only applies to the outdoor unit.
- 4 Refer to the wiring diagram sticker (on the back of the front plate) for instructions on how to use BS1~BS5 and DS1-1, DS1-2 switches.
- 5 Do not operate the unit by short-circuiting protection device S1PH.
- 7 Refer to the installation manual for connection wiring to indoor-outdoor transmission F1-F2.

9.3. System overview of field wiring

(See figure 9)

- 1 Earth leakage breaker
- 2 Field fuse
- 3 Remote controller

9.4. Precautions on wiring of power supply and inter-unit wiring

- Let the power wire (including ground wire and if applicable, the bottom plate heater wire) go through the power outlet port on either the front, side or back of the outdoor unit.
- Let the transmission wires go through the cable outlet port, pipe outlet port or knock out hole on either the front, side or back of the outdoor unit. (See figure 8).

- A Rear direction
- B Lateral direction
- C Front direction
- 1 Power terminal block (X1M)
- 2 Control wiring between units
- 3 Power cable with ground wire. (Keep proper distance between power cable and control wiring).
- 4 Clamp (field supply)
- 5 Stop valve mounting plate
- 6 Power cable
- 7 Ground cable (yellow/green)
- 8 Fix the control wiring with the clamp
- 9 Control terminal block (X2M)
- 10 Interconnection cable for bottom plate heater (ERRQ only)

Precautions when knocking out knockout holes

- To punch a knock hole, hit on it with a hammer.
- After knocking out the holes, we recommend you paint the edges and areas around the edges using the repair paint to prevent rusting.
- When passing electrical wiring through the knock holes, remove any burrs from the knock holes and wrap the wiring with protective tape to prevent damage.
- If there is any possibility that small animals enter the system through the knock holes, plug the holes with packing materials (to be prepared on-site).

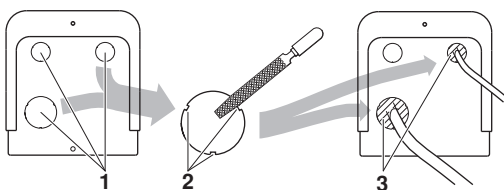

- 1 Knockout hole
- 2 Burr
- 3 Packing materials



- Use a power wire pipe for the power wiring.
- Outside the unit, make sure the low voltage electric wiring (i.e. for the remote control, between units, etc.) and the high voltage electric wiring do not pass near each other, keeping them at least 50 mm apart. Proximity may cause electrical interference, malfunctions, and breakage.
- Be sure to connect the power wiring to the power wiring terminal block and secure it as described under "9.4. Precautions on wiring of power supply and inter-unit wiring" on page 15.
- Inter-unit wiring should be secured as described in "9.4. Precautions on wiring of power supply and inter-unit wiring" on page 15.
 - Secure the wiring with clamps so that it does not touch the piping.
 - Make sure the wiring and the electric box lid do not stick up above the structure, and close the cover firmly.

9.5. Specifications of standard wiring components

A power circuit (see table below) must be provided for connection of the unit. This circuit must be protected with the required safety devices, i.e. a main switch, a slow blow fuse on each phase and an earth leakage breaker.

	ERSQ_V1	ERRQ_V1	ERSQ_Y1	ERRQ_Y1
Phase and frequency	1N~ 50 Hz		3N~ 50 Hz	
Voltage	220-240 V		380-415 V	
Recommended field fuse	32 A		16 A	
Minimum circuit amps ^(a)	27 A	27.5 A	13.5 A	14 A
Transmission line section	0.75~1.25 mm ²			
Wire type ^(b)	H05VV			

(a) Stated values are maximum values (see electrical data of combination with indoor units for exact values).

(b) Only in protected pipes, use H07RN-F when protected pipes are not used.

NOTE



- Select the power supply cable in accordance with relevant local and national regulations.
- Wire size must comply with the applicable local and national code.
- Specifications for local wiring power cord and branch wiring are in compliance with IEC60245.
- The earth leakage circuit breaker must be a high-speed type breaker of 300 mA (<0.1 s).

- In connecting the power cable to the power terminal block, securely clamp the cable as shown in figure 8.



After finishing the electric work, confirm that each electric part and terminal inside the electric parts box is connected securely.

For V1 models only: Equipment complying with EN/IEC 61000-3-12⁽¹⁾.

(1) European/International Technical Standard setting the limits for harmonic currents produced by equipment connected to public low-voltage systems with input current >16 A and ≤75 A per phase.

10. START-UP AND CONFIGURATION



Precautions when laying power wiring

Use round pressure terminals for connections to the power terminal block.

When none are available, follow the instructions below.

- Do not connect wiring of different thicknesses to the power terminal block. (Slack in the power wiring may cause abnormal heat.)
- When connecting wiring which is the same thickness, do as shown in the figure below.

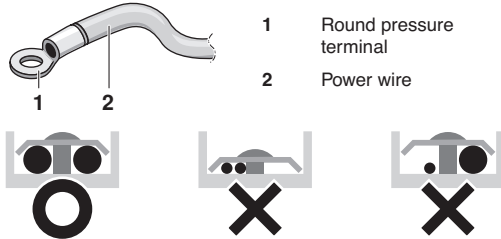

- For wiring, use the designated power wire and connect firmly, then secure to prevent outside pressure being exerted on the terminal board.
- Use an appropriate screwdriver for tightening the terminal screws. A screwdriver with a small head will strip the head and make proper tightening impossible.
- Over-tightening the terminal screws may break them.
- See the table below for tightening torque for the terminal screws.

Tightening torque (N·m)	
M5 (Power terminal block/ground wire)	2.39~2.92
M4 (Shielded ground)	1.18~1.44
M3.5 (Control wiring block)	0.79~0.97

Field line connection: Control wiring



Be sure to follow the limits below. If the unit-to-unit cables are beyond these limits, it may result in malfunction of transmission.

Maximum wiring length: 300 m

Total wiring length: 600 m

- The wiring from the indoor unit must be connected to the F1/F2 (In-Out) terminals on the PC board in the outdoor unit.
- After installing the interconnecting wires inside the unit, wrap them along with the on-site refrigerant pipes using finishing tape, as shown in the figure.

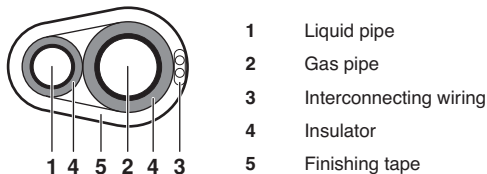

For the above wiring, always use vinyl cords with 0.75 to 1.25 mm² sheath or cables (2-core wires).

10.1. Pre-operation checks



- Make sure that the circuit breaker on the power supply panel of the installation is switched off.
- Attach the power wire securely.
- Introducing power with a missing N-phase or with a mistaken N-phase will break the equipment.

After the installation, check the following before switching on the circuit breaker:

- Transportation stay**
Be sure that the transportation stay is removed from the compressor.
- Power supply wiring and transmission wiring**
Use a designated power supply and transmission wiring and make sure that it has been carried out according to the instructions described in this manual, according to the wiring diagrams and according to local and national regulations.
- Pipe sizes and pipe insulation**
Make sure that correct pipe sizes are installed and that the insulation work is properly executed.
- Additional refrigerant charge**
The amount of refrigerant to be added to the unit should be written on the included "Added Refrigerant" plate and attached to the rear side of the front cover.
- Insulation test of the main power circuit**
Using a megatester for 500 V, check that the insulation resistance of 2 MΩ or more is attained by applying a voltage of 500 V DC between power terminals and earth. Never use the megatester for the transmission wiring.
- Stop valves**
Be sure that the stop valves are open on both liquid and gas side.

11. TEST OPERATION AND FINAL CHECK

11.1. Final check

Items to check	
Electrical wiring Inter-unit wiring Earth wire	<ul style="list-style-type: none"> ■ Is the wiring as mentioned on the wiring diagram? Make sure no wiring has been forgotten and that there are no missing phases or reverse phases. ■ Is the unit properly earthed? ■ Is the wiring between units connected in series correct? ■ Are any of the wiring attachment screws loose? ■ Is the insulation resistance at least 1 MΩ? <ul style="list-style-type: none"> - Use a 500 V mega-tester when measuring insulation. - Do not use a mega-tester for low-voltage circuits.
Refrigerant piping	<ul style="list-style-type: none"> ■ Is the size of the piping appropriate? ■ Is the insulation material for the piping attached securely? Are both the liquid and gas pipes insulated? ■ Are the stop valves for both the liquid side and the gas side open?
Extra refrigerant	<ul style="list-style-type: none"> ■ Did you write down the extra refrigerant and the refrigerant piping length?

- Be sure to perform a test run.
- To protect the compressor, make sure to turn on the power supply 6 hours before starting operation.
- Be sure to fully open the liquid-side and gas-side stop valves. If you operate the unit with stop valves closed, the compressor will break down.
- Never leave the unit unattended with an open front panel during test run.
- After installation, perform the test operation. Unless the test operation is performed, the error code "U3" is shown on the remote controller and the unit cannot be operated.
- During tests never pressurize the appliances with a pressure higher than the maximum allowable pressure (as indicated on the nameplate of the unit).
- Provide a logbook. In accordance with the relevant national and international regulations it may be necessary to provide a logbook with the equipment containing at least:
 - info on maintenance,
 - repair work,
 - results of tests,
 - stand-by periods,
 - ...
 In Europe, EN378 provides the necessary guidance for this logbook.

11.2. Test run

Perform the test run in accordance with the indoor installation manual to ensure that all functions and parts are working properly.

NOTE After turning on the power supply, the unit can not be started until the H2P initialisation led goes off (maximum 12 minutes).

WARNING Live parts can be easily touched by accident. Never leave the unit unattended during installation or servicing when the service panel is removed.

NOTE Note that during the first running period of the unit, required power input may be higher than stated on the nameplate of the unit. This phenomenon originates from the compressor that needs elapse of a 50 hours run in period before reaching smooth operation and stable power consumption.

12. MAINTENANCE AND SERVICING

12.1. Service precautions



WARNING: ELECTRIC SHOCK



Caution when performing service to inverter equipment

- Do not touch live parts for 10 minutes after the power supply is turned off because of high voltage risk.
- Additionally, measure the points as shown in figure 10 with a tester and confirm that the voltage of the capacitor in the main circuit is no more than 50 V DC.
- Make sure that the power supply is turned off before performing the maintenance work. The heater of the compressor may operate even in stop mode.
- Please note that some sections of the electric component box are extremely hot.
- In order to prevent damage to the PCB, first eliminate static electricity by touching a metal part (e.g. stop valve) with your hand. Then pull out the connector.
- After measuring the residual voltage, pull out the outdoor fan connector.
- Make sure you do not touch a conductive section.
- The outdoor fan may rotate due to strong backblow wind, causing the capacitor to charge. This may result in an electric shock.

After maintenance, make sure the outdoor fan connector is connected again. Otherwise, the unit may break down.



Play it safe!

Touch a metal part by hand (such as the stop valve) in order to eliminate static electricity and to protect the PCB before performing service.

12.2. Service mode operation

If required, carry out any service mode operation according to the following instructions. Refer to the service manual for more details.

Setting the mode

The set mode can be changed with the **BS1 MODE** button according to the following procedure:

- **For setting mode 1:** Press the **BS1 MODE** button once, the H1P LED is off ●.
- **For setting mode 2:** Press the **BS1 MODE** button for 5 seconds, the H1P LED is on ☀.

If the H1P LED is blinking ☀ and the **BS1 MODE** button is pushed once, the setting mode will change to setting mode 1.

NOTE If you get confused in the middle of the setting process, push the **BS1 MODE** button. Then it returns to setting mode 1 (H1P LED is off).

Location of the dip switches, LEDs and buttons

- 1 Led H1P~H8P
- 2 Push button switches BS1~BS5
- 3 DIP switches (do not use or change)

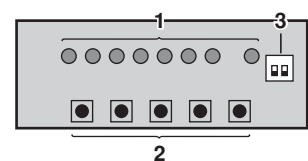

LED state

Throughout the manual the state of the LEDs is indicated as follows:

● OFF ☀ ON ☀ blinking

Setting the mode

- 1 Push the **BS2 SET** button to set the required function (refrigerant recovery operation/vacuumping operation) to **ON** (ON).

The H3P, H5P and H7P LEDs are on.



- 2 When the **BS3 RETURN** button is pushed, the LEDs are indicating the current setting.
- 3 To set this function **ON** (ON) or **OFF** (OFF), push the **BS2 SET** button as shown below.

	H1P	H2P	H3P	H4P	H5P	H6P	H7P
ON	☀	●	●	●	●	☀	●
OFF ^(a)	☀	●	●	●	●	●	☀

(a) This setting = factory setting

- 4 Push the **BS3 RETURN** button and the setting is defined.
- 5 When the **BS3 RETURN** button is pushed again, the operation starts according to the setting.

Vacuumping method

At the first installation, this vacuumping is not required. It is required only for repair purposes.

- 1 When the unit is at a standstill and under the setting mode 2, set the required function (refrigerant recovery operation/vacuumping operation) to **ON** (ON).
 - After this is set, do not reset the setting mode 2 until the vacuumping is finished.
 - The H1P led is on and the remote controller indicates **TEST** (test operation) and  (external control) and the operation will be prohibited.
- 2 Vacuum the system with a vacuum pump.
- 3 Press the **BS1 MODE** button and reset the setting mode 2.

Refrigerant recovery operation method by a refrigerant reclaimer.

- 1 When the unit is at a standstill and in setting mode 2, set the required function (refrigerant recovery operation/vacuumping operation) to **ON** (ON).
 - The indoor unit and the outdoor unit expansion valves will fully open and some solenoid valves will open.
 - The H1P led is on and the remote controller indicates **TEST** (test operation) and  (external control) and the operation will be prohibited.
- 2 Recover the refrigerant using a refrigerant reclaimer. For details, see the operation manual delivered with the refrigerant reclaimer.
- 3 Press the **BS1 MODE** button and reset the setting mode 2.



CAUTION

Never turn the power of the outdoor unit OFF while the refrigerant is being recovered.

If the power is turned OFF, the solenoid valves are closed and the refrigerant cannot be recovered from the outdoor unit.

Pump down operation

This unit is equipped with an automatic pump down operation which will collect all refrigerant from the field piping and indoor unit in the outdoor unit. To protect the environment, make sure to perform the following pump down operation when relocating or disposing of the unit.



- The outdoor unit is equipped with a low pressure switch or a low pressure sensor to protect the compressor by switching it off. Never short-circuit the low pressure switch during pump down operation!
- Do not execute the pump down operation if the piping length between the outdoor unit and the indoor unit is longer than 10 m. This may cause damage to the unit.

1. Turn on the main power supply.
2. Make sure the liquid stop valve is closed and the gas stop valve is open (see "6.3. Guidelines for handling stop valve" on page 9).
3. Switch the service mode 2-61 from OFF to ON.
4. The compressor and outdoor unit fan will start operating automatically. During operation, the LEDs are showing the progress as shown in the figure.

	H1P	H2P	H3P	H4P	H5P	H6P	H7P
Step 1	●	☀	☀	☀	☀	☀	☀
Step 2	●	☀	●	☀	☀	☀	☀
Step 3	●	☀	●	●	☀	☀	☀
Step 4	●	☀	●	●	●	☀	☀
Step 5	●	☀	●	●	●	●	☀

5. If step 5 is reached (pressure drops below 3 bar) or if operation stops (after 30 minutes), close the gas stop valve.
6. Turn off the main power supply.



Make sure to re-open both stop valves before restarting operation of the unit.

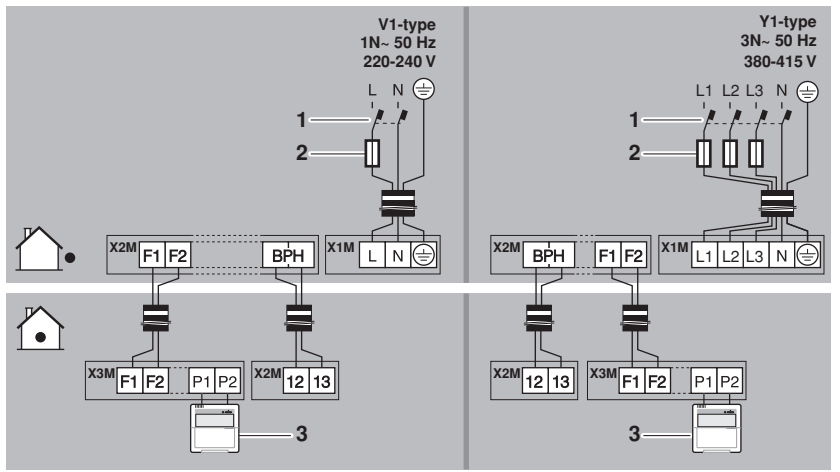
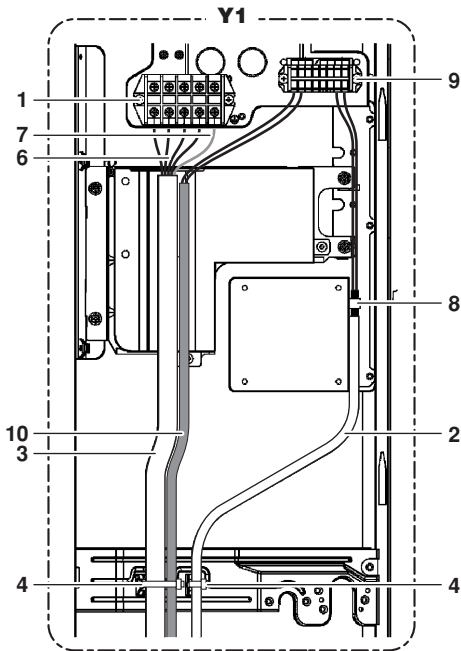

9

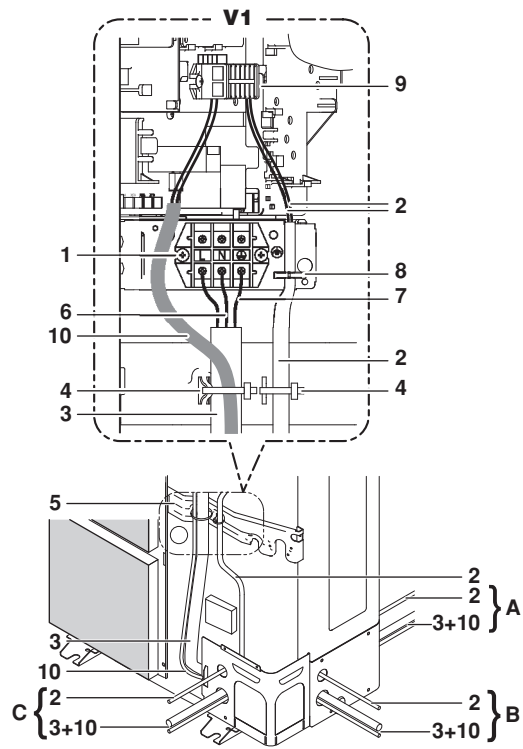

8

V1

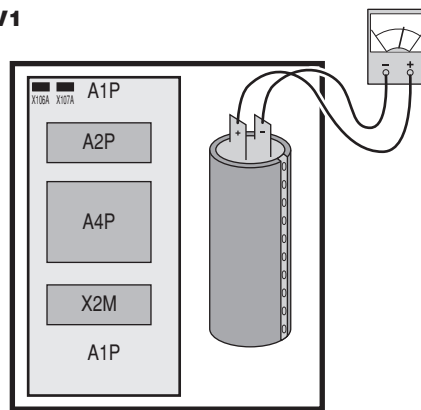

Y1

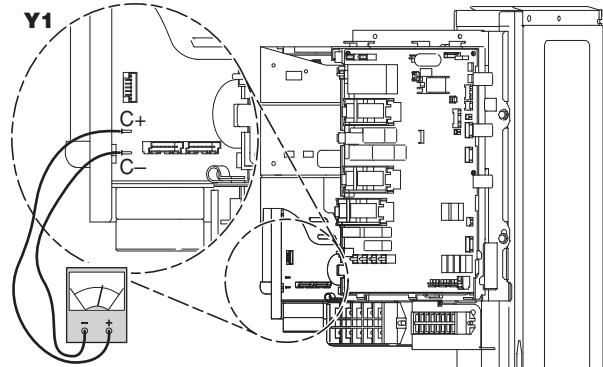

10

NOTES





4PW49635-1 C 000000V

Copyright 2010 Daikin

DAIKIN EUROPE N.V.

Zandvoordestraat 300, B-8400 Oostende, Belgium

4PW49635-1C